

ПОРТФОЛИО

2024

Содержание

А	Аер..... 180	К	Канон 1..... 175	О	Ольса..... 122
	Азалия..... 177		Кант..... 145		Омега..... 70
	Аква..... 176		Кембридж Сити..... 79		Орегон 1..... 189
	Аксель 1..... 166		Кенни..... 50		Орио 1..... 203
	Алан..... 92		Кларк 1..... 163		Осирис..... 148
	Алези..... 4		Клёк..... 193		Оскар 11..... 203
	Ален 1..... 169		Коламбус..... 61		Осорно..... 142
	Амазонка 1..... 182		Консул-2020..... 76		Отто..... 53
	Амарис..... 46		Консул-24..... 78	П	Палац..... 201
	Аргус 1..... 151		Корк..... 135		Паркер 1..... 125
	Ариэль..... 191		Корлеоне..... 16		Петра 1..... 208
Б	Бали..... 86		Корфу..... 84		Питсбург..... 64
	Бариста..... 140		Кредо..... 8		Плаза..... 66
	Барни 1..... 146		Крок..... 204		Платон 1..... 196
	Барселона 2..... 38		Куби..... 104		Пэрис 1..... 144
	Баттерфляй..... 156	Л	Кэт..... 211	Р	Редфорд..... 40
	Бейкер..... 58		Лаваль..... 188		Рейн 1..... 162
	Бергамо..... 176		Ларс..... 201		Ричмонд..... 42
	Берли 1..... 209		Латина Royal..... 14		Роберто..... 108
	Блэк 1..... 120		Латте 1..... 152		Роджер..... 127
	Болеро..... 80		Лейла 1..... 184		Ронда 1..... 208
	Бонда..... 204		Леруа..... 60		Ронни 1..... 171
	Бони 1..... 168		Лира 1..... 204		Рунь..... 211
	Бонсай 1..... 101		Локи 1..... 190		Рэм 1..... 167
	Босфор 1..... 100		Лонди..... 128	С	Самос..... 93
	Боттичелли..... 11		Лорд 1..... 199		Светач..... 207
	Брабус..... 102		Люксор..... 68		Симон 1..... 197
	Бриз 1..... 195		Люси Плюс..... 170		Скош 1..... 210
	Бродвей..... 106		Лясэ..... 205		Сохо..... 57
	Бруклин..... 30	М	Магнат..... 90		Спирит..... 126
	Бэк-2..... 174		Мадлен..... 10		Стефано 1..... 124
В	Вагнер..... 162		Малибу..... 82	Т	Твен..... 94
	Веймар Плюс..... 164		Манчестер 1..... 48		Твит..... 136
	Верди..... 5		Мариша..... 186		Тибо 1..... 123
	Вестерн..... 118		Марракеш..... 114		Томсон 1..... 178
	Вива..... 138		Марсел 1..... 198	У	Уно 2..... 28
Г	Гмах 3..... 123		Матео Люкс..... 158	Ф	Фарго 1..... 179
Д	Дакар 2..... 130		Матисс Люкс..... 160		Фландер..... 24
	Дана 1..... 200		Мелдон..... 54		Фонс..... 207
	Дельта..... 72		Мелисса..... 172	Ц	Цезарь..... 12
	Денди 1..... 185		Миллари..... 110	Ч	Чара..... 205
	Джой..... 200		Милорд 1..... 209		Чери 1..... 120
	Дориан 2..... 98		Милтон..... 26	Ш	Шарон..... 134
	Дорса..... 116		Мирано..... 34		Шелби Плюс..... 183
	Дубай..... 112		Мишель..... 44	Э	Эльф 1..... 194
З	Завея..... 143		Молина..... 186		Эрика 1..... 129
	Золак 2..... 149		Молли..... 52	Ю	Юта 1..... 147
И	Изабель..... 74		Монро 1..... 132	Я	Ямайка..... 91
	Икар..... 192	Н	Мэри 1..... 134		Кисти, бахрама, шнуры..... 212
	Империал..... 18		Нео 1..... 181		Крашения..... 213
	Инфинити Люкс..... 154		Никки..... 192		Условные обозначения..... 216
	Ирис 1..... 22		Николь..... 20		
	Йорк..... 62		Нова..... 193		
К	Кауа..... 202		Нью-Йорк..... 96		
	Кауа 1..... 202	О	Один..... 150		
	Камила..... 206		Ойра..... 121		
			Оливер..... 88		

Алези, Алези Royal



Royal_30211+30211(0), 26 гр., 2М



royal_30210+30210(0), 26 гр., 2М



31564(0)+31563, 25 гр., 2М



royal_911+911(0), 21 гр., 2М, сл кость с зол_ПВ-32_394В-0687



31122+31121(0), 23 гр., 2М



984+984, 19 гр., 2М_



31011+31011(0), 25 гр., 2М



royal_914+914(0), 21 гр., 2М



royal_815+815(0), 24 гр., 2М

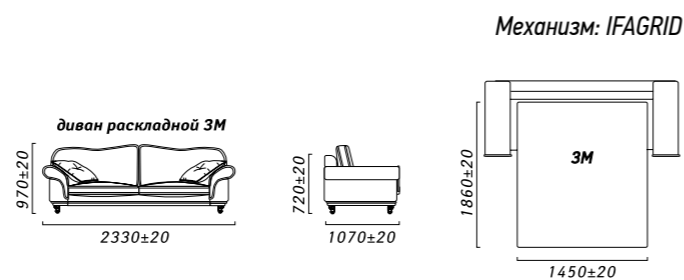

Верди 3МТ Royal, Верди Royal



royal_31011+788+31011(0), 25 гр., 3МТ



royal_813+813(0)+520, 24 гр., 3М



royal_31014+885+31014(0), 25 гр., 3МТ



royal_30212+30212(0)+31116(0), 26 гр., 3М



royal_909+777+777, 21 гр., 3М



royal_910+910(0)+30167, 21 гр., 3М



royal_30213+30213(0)+34524, 26 гр., 3М



royal_30015+30015(0)+654, 24 гр., 3М



royal_815+656+653, 24 гр., 12

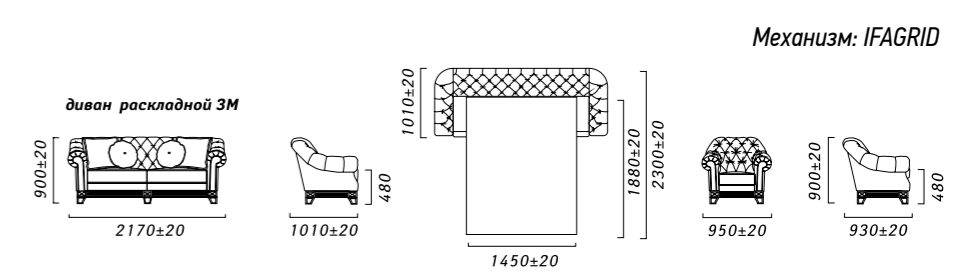



149(0)+149(0)+911(0), 19 гр., 3М



151+606+30213(0), 20 гр., 3М



449+412+412, 20 гр., 3М



514+514+513, 20 гр., 3М_табак



661+31569+31569(0), 23 гр., 3М



672+908+908(0), 23 гр., 3М



362+362+362, 21 гр., 32



654+654+653, 19 гр., 3М



30166+30166+30167, 20 гр., 3М



30175+908(0)+30167, 20 гр., 3М



royal_31012+782+31012(0), 25 гр., 3МТ



royal_812+812(0)+980, 24 гр., 3МТ



885+30167+31014, 21 гр., 3МТ



836+836(0)+393, 24 гр., 3МТ



30164+31213(0)+30165, 20 гр., 3М



31117+31115(0)+31115, 23 гр., 3МТ



675+665+664, 23 гр., 3МТ



515+513+710, 20 гр., 3МТ, P43 с патиной



501, 22 гр., 12

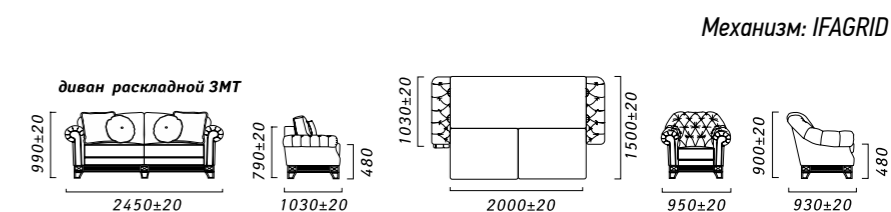

Кредо



31014+885+31014(0), 25 гр., 3М



31015+889+31015(0), 25 гр., 3М



31016+882+31016(0), 25 гр., 3М



30215+30215(0)+30167, 26 гр., 3М



30216+30165+30216(0), 26 гр., 3М



31121+31121(0)+31121(0), 23 гр., 3М



815+815(0)+31591(0), 24 гр., 3М



912+912(0)+31578(0), 21 гр., 3М



31115+31115(0), 23 гр., 12



652, 19 гр., 12



816+990+990, 24 гр., 18

Кредо



811+811(0)+814(0), 24 гр., 3М



816+31591(0)+911(0), 24 гр.,



913+31589(0)+913(0), 21 гр., 3М



30013+30014+30013, 24 гр., 3М



30015+30165+30015(0)+30015, 24 гр., 3М



30213+31587(0)+30213(0), 26 гр., 3М



30214+31582(0)+30214(0), 26 гр., 3М

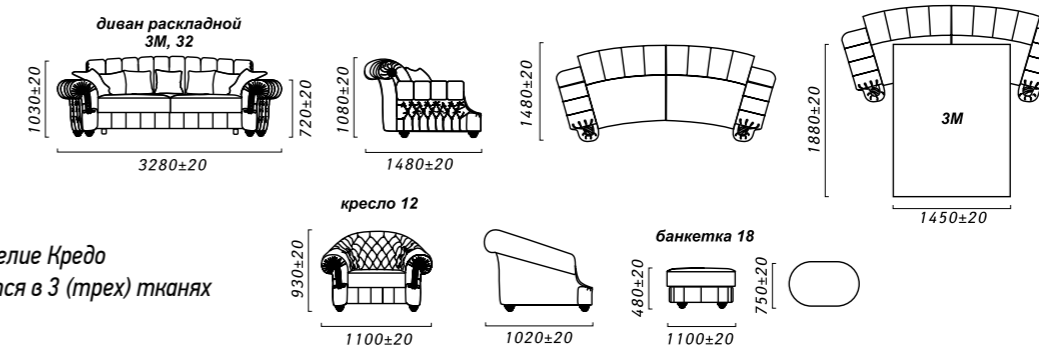

С 2020 г. изделие Кредо комбинируется в 3 (трех) тканях

Механизм «IFAGRID»

Мадлен Royal



royal_31012+31012(0)+31012+778, 25 гр., 4L.30M.4R



royal_811+811(0)+30129, 24 гр., 3M



royal_31015+31015(0)+31015+777, 25 гр., 4L.30M.4R



606+31566(0)+31566(0)+776, 24 гр., 3M



royal_815+989+815+989, 24 гр., 4L.30M.4R



royal_909+909(0)+31578(0)+31592(0), 21 гр., 3M



royal_915+915(0)+915+911(0), 21 гр., 4L.30M.4R



royal_31571+34536+34515+34515, 25 гр., 3M



royal_30213+30213(0)+30213(0)+35330, 26 гр., 4L30M4R



royal_31115+31115(0)+31116+31115(0), 23 гр., 3M

Мадлен



204+811(0)+30213(0)+815(0), 22 гр., 3M



royal_31557+31566(0)+31583, 25 гр.

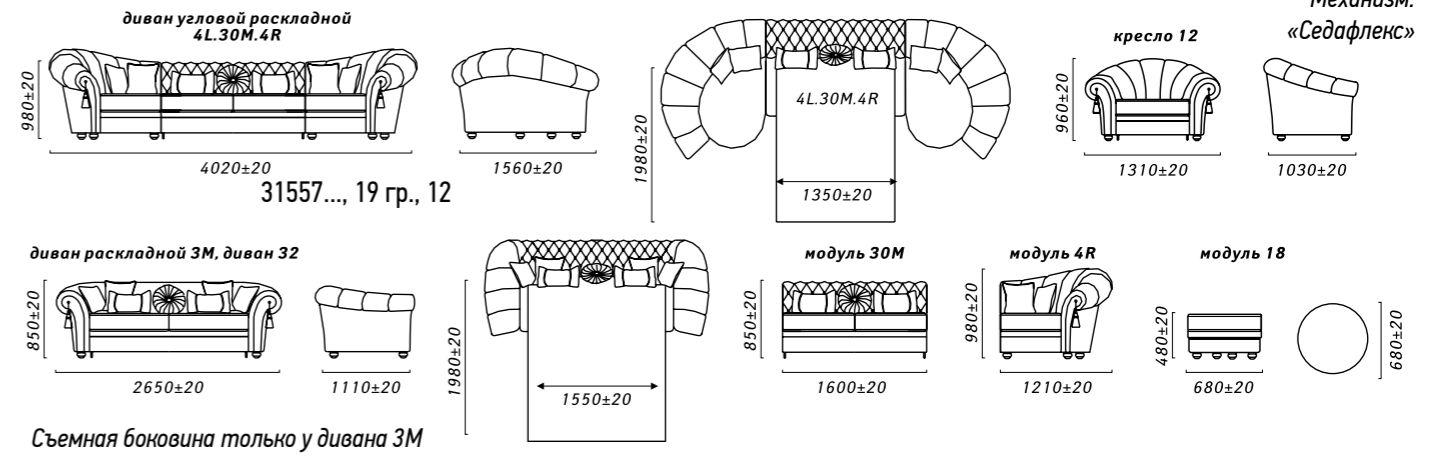

Боттичелли



412, 20 гр., 4M



959, 19 гр., 4M



949, 19 гр., 4M



949, 19 гр., 18



790, 20 гр., 12

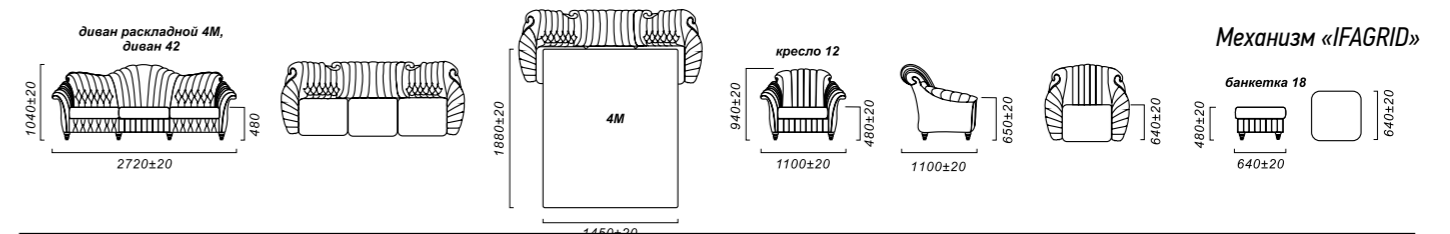



31566+31566(0), 25 гр., 3ML.90.1R



913+959, 21 гр., 12



911+911(0), 21 гр., 3ML.90.1R



908+908(0), 21 гр., 12



30015+30016, 24 гр., 3ML901R



30211+30211(0), 26 гр., 22



30213+30213(0), 26 гр., 3ML901R



31121+31122(0), 23 гр., 12



31567+31567(0), 25 гр., 3ML.90.1R



519+519, 20 гр., 22_сл к_ПВ-76_102-13552



31569+31569(0), 25 гр., 3M



30185+30282, 24 гр., 3M



30212+30212(0), 26 гр., 3M



812+812(0), 24 гр., 3M



816+816(0), 24 гр., 3M



811+811(0), 24 гр., 3M



909+911(0), 21 гр., 3M_sl k s pat_PW-32_102-0109



30211+656, 26 гр., 3M

Механизм «Сседафлекс 12М-160»

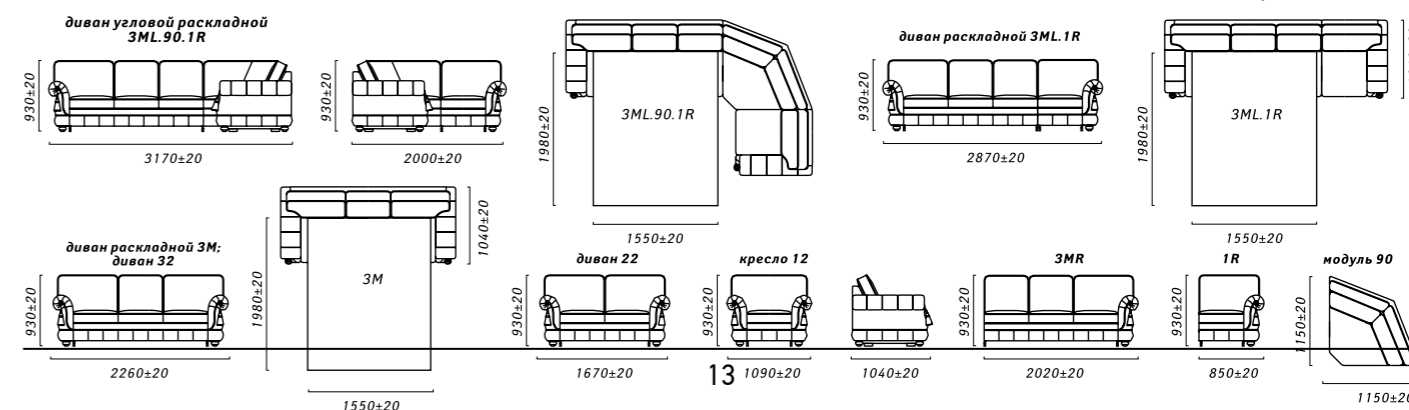

Латина Royal

Независимый пружинный блок
Pocket Spring



30211+30211(0)+815(0), 26 гр., 3ML.90.1R



royal_31011+31011(0)+864, 25 гр., 3M



30213+34206+30213(0), 26 гр., 3ML.90.1R



royal_31012+782+31012(0), 25 гр., 3M



31121+31122(0)+31119, 23 гр., 3ML.90.1R



30210+30210(0)+30162, 25 гр.



31216+30166+31216(0), 24 гр., 3ML.90.1R



royal_30001+30016+30001(0), 24 гр.



30013+30014+30013(0), 24 гр., 3M



31115+31122(0)+31116, 23 гр., 3M

Латина Royal

Независимый пружинный блок
Pocket Spring



815+815(0)+31588(0), 24 гр., 3M



912+979+912(0), 21 гр., 3M



908+31042+908(0), 21 гр., 3M



909+34155+909(0), 21 гр., 3M



914+672+914(0), 21 гр., 3M



915+915(0)+446, 21 гр., 3M



952+952+952, 19 гр., 3M

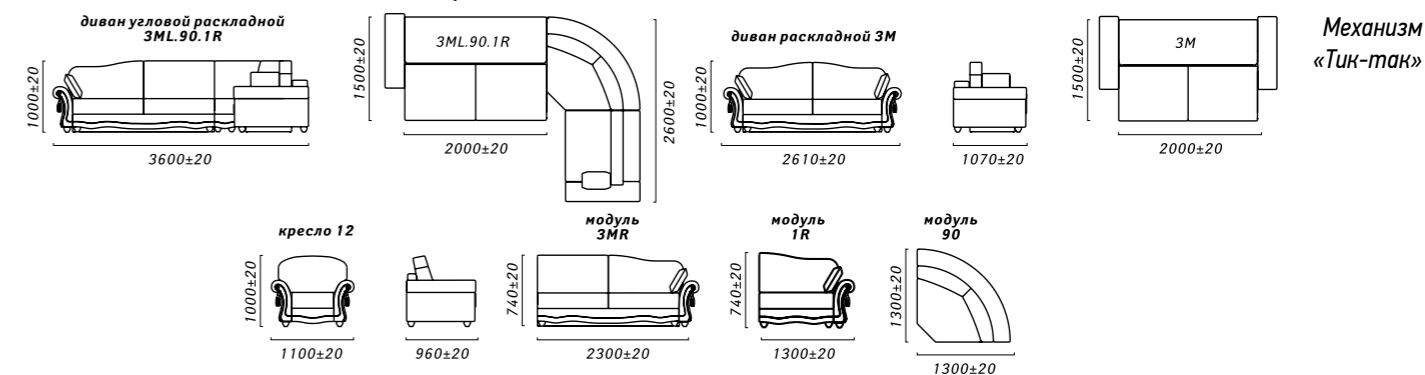

Корлеоне



675+677, 23 гр., 3ML.90.1R



7(0)+909(0), 19 гр., 3M



554+812, 21 гр., 3ML.90.1R



521+30211, 21 гр., 3M



431+908, 23 гр., 3ML.90.1R



559+915(0), 21 гр., 3M



653+911, 19 гр., 3ML.90.1R



672+30339, 23 гр., 3M



558+812, 21 гр., 3ML.90.1R



555+811, 21 гр., 3M

Корлеоне 1



422+913, 23 гр., 3ML.90.1R



424+910(0), 23 гр., 3M



435+913, 23 гр., 3ML.90.1R



432+658, 23 гр., 3M



675+664, 23 гр., 3M



560+814, 21 гр., 3M



664+914, 23 гр., 3M



551, 21 гр., 12

диван угловой раскладной 3ML.90.1R
диван угловой 3L.90.1R

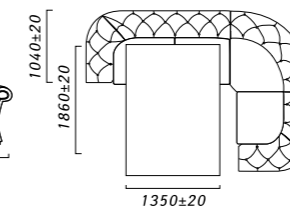
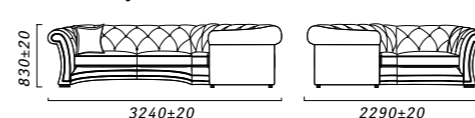

диван раскладной 3M:
диван 32

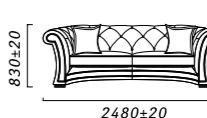

кресло 12

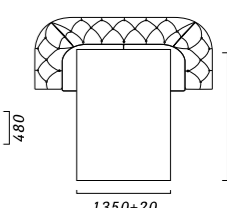

Механизм «IFAGRID»

Империял



908+908(0), 21 гр., 3М



813+31591, 24 гр., 3М



30211+30211(0), 26 гр., 3М



30213+30213(0), 26 гр., 3М



30212+30212(0), 26 гр., 3М



30013+30013(0), 24 гр., 3М



30214+30214(0), 26 гр., 3М



30214+30214(0), 26 гр., 12



31566+31566(0), 25 гр., 3М



31566+31566(0), 25 гр., 12

Империял



914+914(0), 21 гр., 3М



914+914(0), 21 гр., 12



30015+30015(0), 24 гр., 3М



30015+30015(0), 24 гр., 12



31121+31122, 23 гр., 3М



31121+31122, 23 гр., 12



30215+30215(0), 26 гр., 12

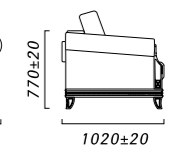
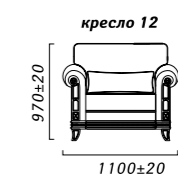
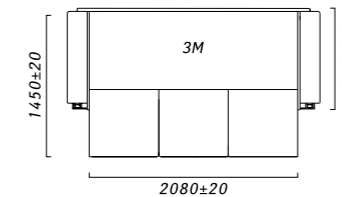
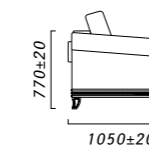
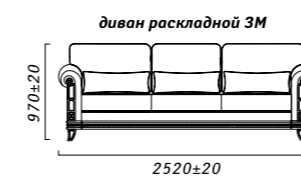

Механизм «Тик-так»



royal_908+653+908, 21 гр., 3М



royal_30210+30171+30210(0), 26 гр., 3М



912(0)+34199+912, 21 гр., 3М



957+957+946, 19 гр., 3М



657+34514+34387(0), 19 гр., 3М



659+652+653, 19 гр., 3М



990+979+816, 20 гр., 3М



royal_816+815(0)+815(0), 24 гр., 12

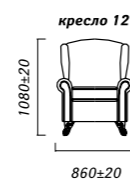
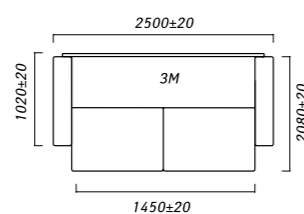
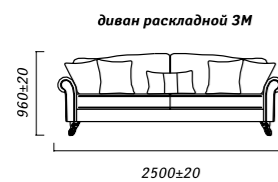

Механизм «Тик-так»



412+412+911(0), 20 гр., 3М



148(0)+953+149(0), 19 гр., 3М



205+30163+30169, 22 гр., 3М



515+515+515, 20 гр., 3М



517+513+517, 20 гр., 3М_P46



556+556+30015, 21 гр., 3М



607+35021+35019, 24 гр., 3М



610+982+613, 24 гр., 3М



653+653+911, 19 гр., 3М



654+657+30015(0), 20 гр., 3М

Ирис 1



449+450+908, 20 гр., 4М



838+838(0)+830(0), 24 гр., 3М



955+949+945, 19 гр., 4М



8(0)+5+8(0), 19 гр., 3М



1017+1016+31594, 18 гр., 4М



205+811(0)+816(0), 22 гр., 3М



31589(0)+766+30314, 19 гр., 4М



953+953+947, 19 гр., 3М, P43



Iris_1_610+655+610, 24 гр., 3М



31592(0)+31592+816, 19 гр., 3М

Ирис 1



30315+30165+30161, 22 гр., 4М



677+677+677, 23 гр., 3М



30346+30170+30162, 23 гр., 4М



517+514+513, 20 гр., 3М



30260+30170+30172, 19 гр., 3М



657+657+30339, 19 гр., 3М



559+563+563, 21 гр., 18



449+450, 20 гр., 18



610+655+610, 24 гр., OR

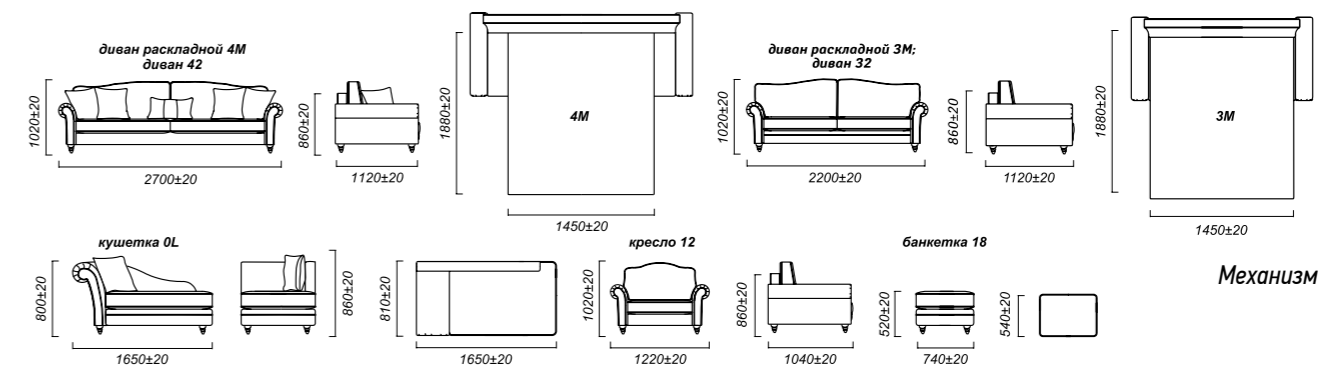

Фландер



837+837(0)+30050, 24 гр., 3М



7(0)+7(0)+653, 19 гр., 3М



205+989+977, 22 гр., 3М



206+31591(0)+31582(0), 22 гр., 3М



8+153+31594, 19 гр., 3М



514+908(0)+908, 20 гр., 3М



557+556+30013(0), 21 гр., 3М



653+911(0)+911, 19 гр., 3М



912(0)+655+652, 21 гр., 3М



654+653+655, 19 гр., 3М

Фландер



611+30176+30164, 22 гр., 3М



613+982+610, 24 гр., 3М



633+681+690, 23 гр., 3М



982+989+711, 19 гр., 3М



657+30212+30212(0), 20 гр., 3М



658+653+656, 19 гр., 3М



957+949+951, 19 гр., 3М



608, 24 гр., 12



30274, 19 гр., 12

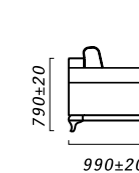
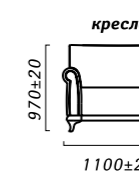
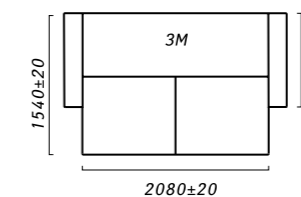
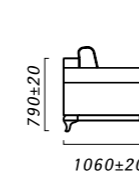

Механизм «Тик-так»

Милтон, Милтон Royal



royal_31011+31011(0)+776, 25 гр., 3М



30015+30016+30014, 24 гр., 3М



royal_912+912(0)+653, 21 гр., 3М



royal_30216+30216(0)+430, 26 гр., 3М



977+977+980, 19 гр., 3М



982+982+978, 19 гр., 3М



30168+30168+30165, 20 гр., 3М



royal_908+908(0)+653, 21 гр., 3М

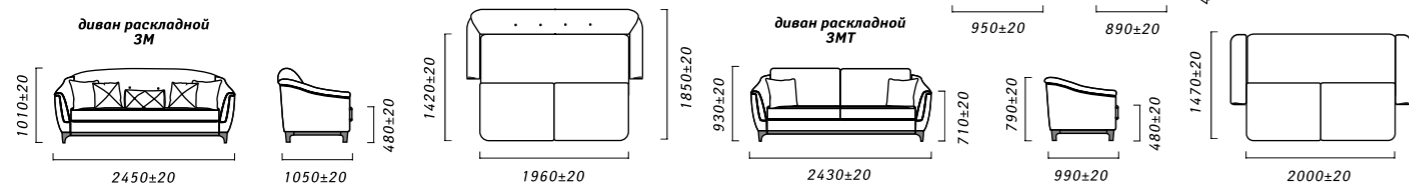

Милтон 3МТ



722+717, 19 гр., 3МТ



30295+360, 23 гр., 3МТ



5+8(0), 19 гр., 3МТ



949+959, 19 гр., 3МТ



910(0)+1020, 21 гр., 3МТ



658+652, 19 гр., 3МТ



652+652, 19 гр., 3МТ



955+946, 19 гр., 3МТ



950+949, 19 гр., 3МТ



982+982+978, 19 гр., 12



480+946+910(0), 19 гр., 2ML.8MR



31038+31040+31012, 20 гр., 3М



31034+34984+34950, 19 гр., 3М



486+480+31594, 19 гр., 3М



652+653+654, 19 гр., 2ML.8MR



30297+30292(0)+30294, 23 гр., 3М



250+307+603, 20 гр., 2ML.8MR



443+30274+30281, 20 гр., 3М



31504+30171+912(0), 19 гр., 2ML.8MR



559+558+558, 21 гр., 3М



477+946+914(0), 19 гр., 2ML.8MR



997+30288+30051, 19 гр., 3М



30317+30183+30179, 22 гр., 3М



30315+30320+30218, 22 гр., 3М



910(0)+788+910, 22 гр., 3М



30284+518+30051, 22 гр., 3М



517+516+811, 20 гр., 3М



362+361+359, 21 гр., 3М

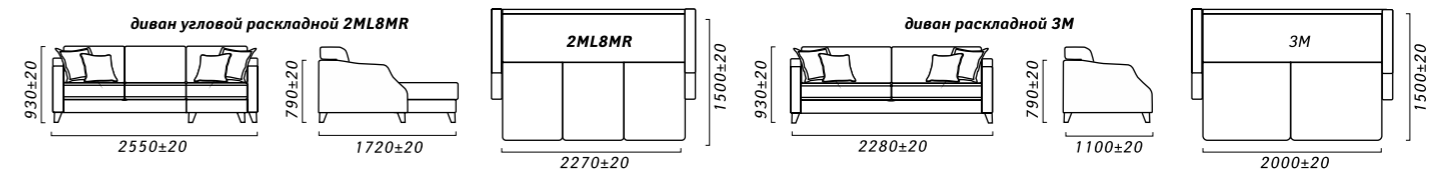



6(0)+31594, 19 гр., 3М



9(0)+911(0), 19 гр., 3М



416+412, 20 гр., 3М



419+31505, 20 гр., 3М



517+632_3m



521+607, 20 гр., 3М



653+654, 19 гр., 3М



654+710, 19 гр., 3М



718+30348, 19 гр., 3М



362+632, 19 гр., 3М



977+31597, 19 гр., 3М



979+31596, 19 гр., 3М



983+31597, 19 гр., 3М



988+913, 19 гр., 3М



989+30281, 19 гр., 3М



1012+710, 18 гр., 3М



30164+31595, 20 гр., 3М



30170+30345, 20 гр., 3М

Механизм «Тик-так»

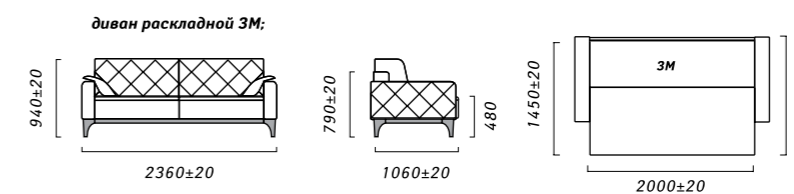

Бруклин 2



718, 19 гр., 2ML.8MR



30136, 20 гр., 3M



6(0), 19 гр., 2ML.8MR



519, 20 гр., 3M



450, 20 гр., 2ML.8MR



31582(0), 19 гр., 3M



979(0), 19 гр., 2ML.8MR



31585(0), 19 гр., 3M



775, 19 гр., 2ML.8MR



414, 20 гр., 3M

Бруклин 2



359, 21 гр., 2ML.8MR



717, 19 гр., 3M



31578(0), 19 гр., 2ML.8MR



8(0), 19 гр., 3M



365, 21 гр., 2ML.8MR



715, 19 гр., 3M



366, 21 гр., 2ML.8MR



30137, 20 гр., 3M

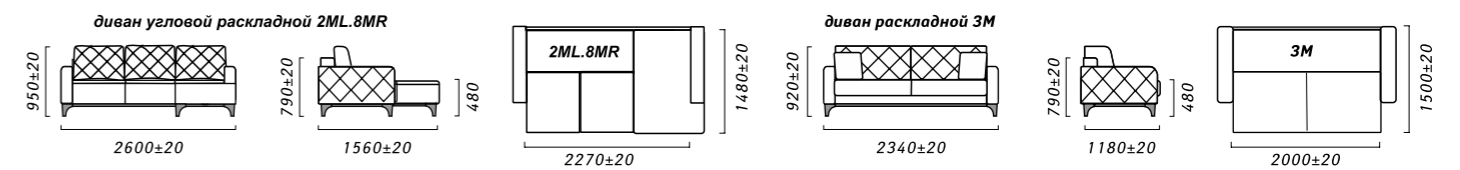

Мирано



149, 19 гр., 8ML.30M.90.1R



1241, 120 гр., 3M



214, 19 гр., 8ML.30.90.1R



443, 20 гр., 3M



523, 20 гр., 1EL.30.90.1ER



2345, 150 гр., 3M



2328, 140 гр., 1EL.30M.8MR



208, 19 гр., 3M



1012, 18 гр., 8ML.30M.90.10.1ER



493, 22 гр., 3M

Мирано



2343, 150 гр., 3ML.90.1ER



1247, 120 гр., 3M



653, 19 гр., 3L.90.1R



518, 20 гр., 3M



359, 21 гр., 3ML.90.1R



5, 19 гр., 3M



661, 23 гр., 3L.90.10.1R



2341, 150 гр., 3M



2311, 140 гр., 3ML.90.1R



2352, 140 гр., 3M



3038, 150 гр., 3ML.8MR



366, 21 гр., 3ML1R



419, 20 гр., 3ML.8MR



2313, 140 гр., 3ML.1R



502, 22 гр., 3ML.8MR



986, 19 гр., 3ML.1R



553, 21 гр., 3ML.8MR



30164, 20 гр., 3ML.1R



2350, 140 гр., 3ML.8MR



2344, 150 гр., 3M



435, 23 гр., 1L.30M.8MR



2067, 120 гр., 3M

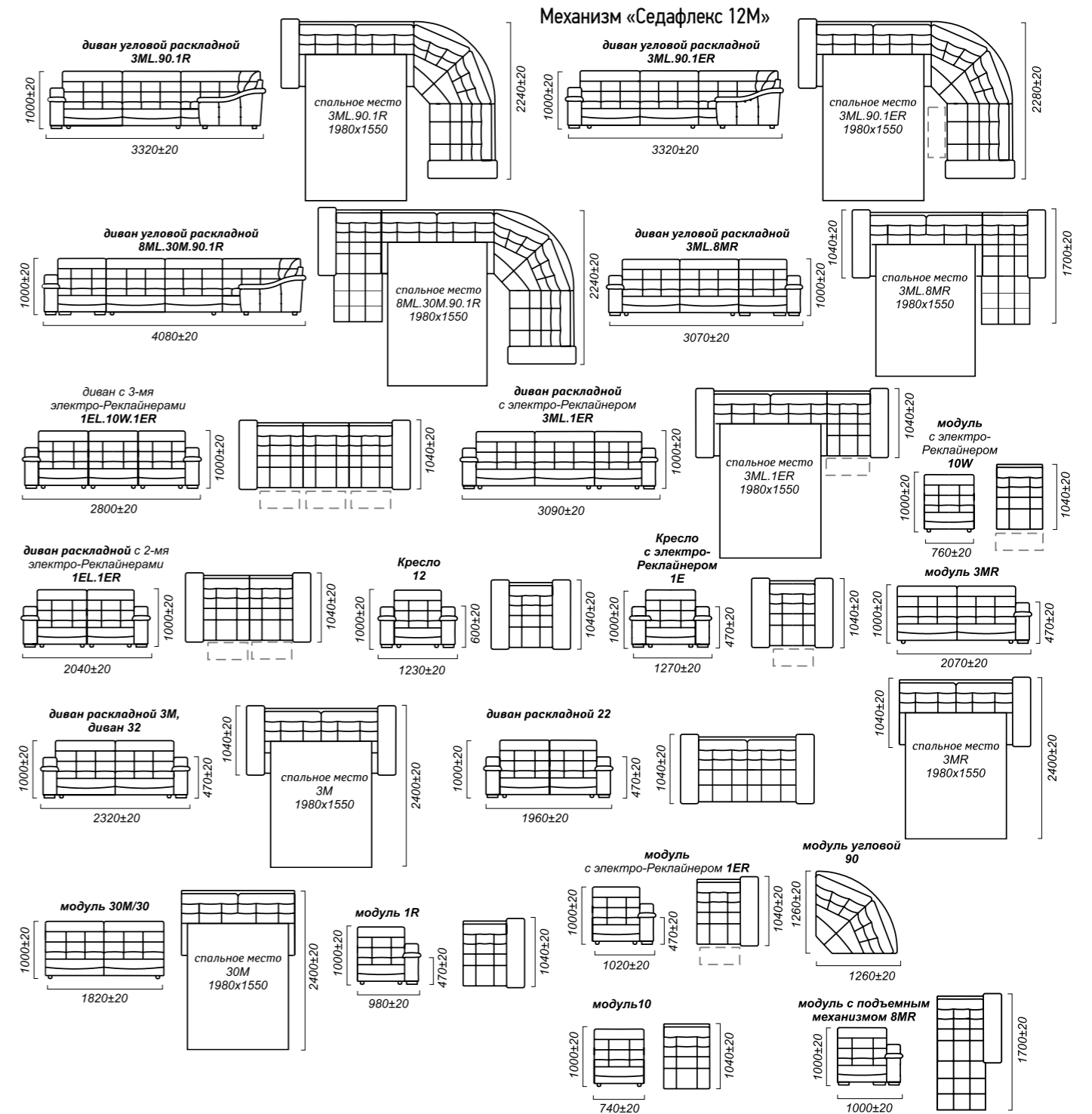

Барселона 2



2324, 140 гр., 3ML.90.1R



2352, 140 гр., 3M



210, 19 гр., 3ML.90.1R



2344, 150 гр., 3M



549, 21 гр., 3ML.90.1R



2063, 120 гр., 3M



550, 21 гр., 1L30M8MR



1240, 120 гр., 3M



502, 22 гр., 8ML30M8ML



414, 20 гр., 3M

Барселона 2



412, 20 гр., 3ML.8MR



422, 23 гр., 3ML.8MR



435, 23 гр., 3ML.8MR



430, 23 гр., 3MR1L



2341, 150 гр., 3ML.90.1R



2328, 140 гр., 3M



951, 19 гр., 8ML30901R



3340, 120 гр., 12

Механизм «Вперед выкатной»

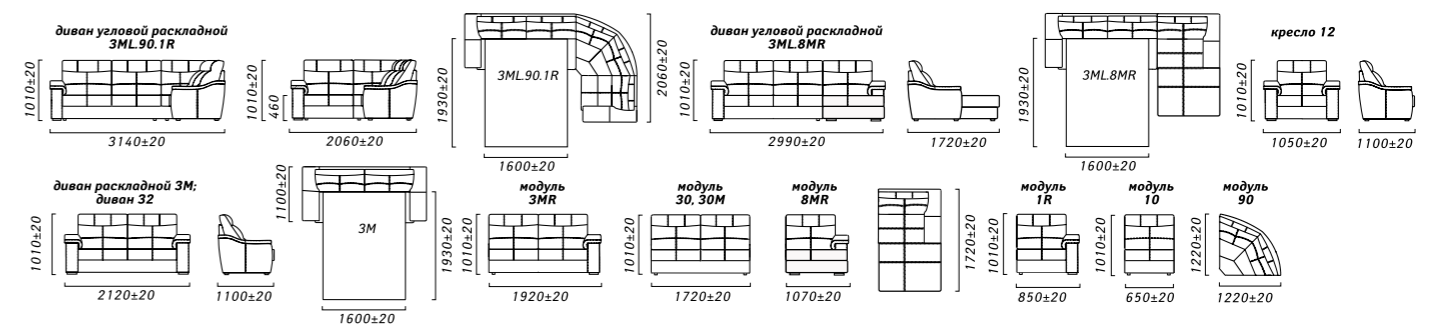

Редфорд



2344, 150 гр., 3ML.90.1R



3081, 120 гр., 3M



2342, 150 гр., 8ML.30M.90.1R



2328, 140 гр., 3M



3051, 140 гр., 8ML.30M.90.1R



447, 20 гр., 3M



560, 21 гр., 1L.30M.1R



2345, 150 гр., 3M



499, 22 гр., 8MR.30M.90.1L



2008, 120 гр., 3M

Редфорд



3038, 150 гр., 3ML.8MR



208, 19 гр., 3MR.1L



2341, 150 гр., 3ML.8MR



424, 23 гр., 3ML.1R



551, 21 гр., 3MR.1L



2005, 120 гр., 18

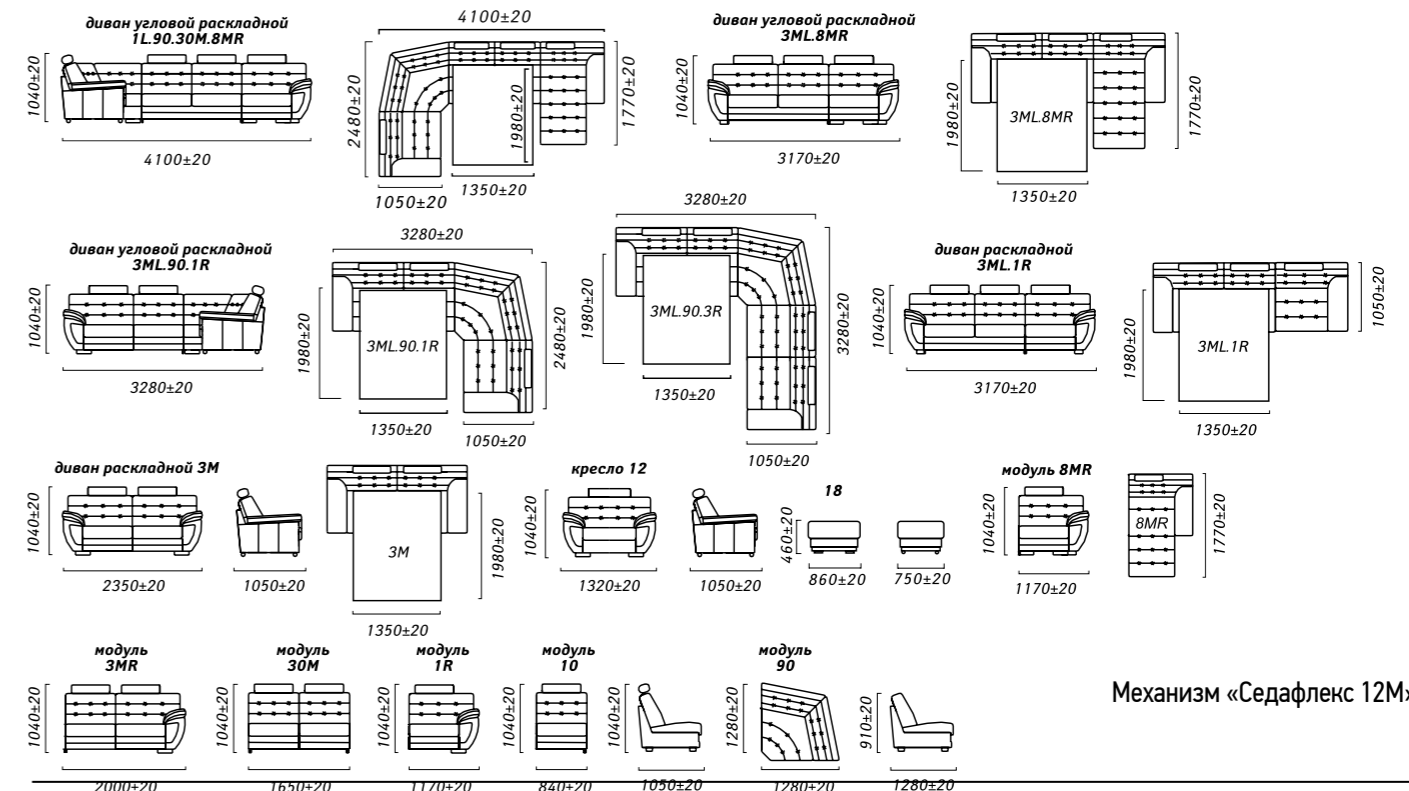

Механизм «Седафлекс 12М»

Ричмонд



3340, 1R.90.30M.8ML



1232, 120 гр., 3M



2311, 140 гр., 3ML.90.1R



1244, 120 гр., 3M



2310, 140 гр., 3ML.90.1R



1246, 120 гр., 3M



2063, 120 гр., 3ML.8MR



2342, 150 гр., 3M



432, 23 гр., 1R.90.30M.8ML



149(0), 19 гр., 12

Ричмонд



435, 23 гр., 3ML.90.1R



653, 19 гр., 3ML.1R



555, 21 гр., 3ML.90.1R



501, 22 гр., 3ML.8MR



556, 21 гр., 3ML.90.1R



3(0), 19 гр., 3ML.8MR



432, 23 гр., 3ML.8MR



675, 23 гр., 3ML.1R

Механизм: «Вперед выкатной»

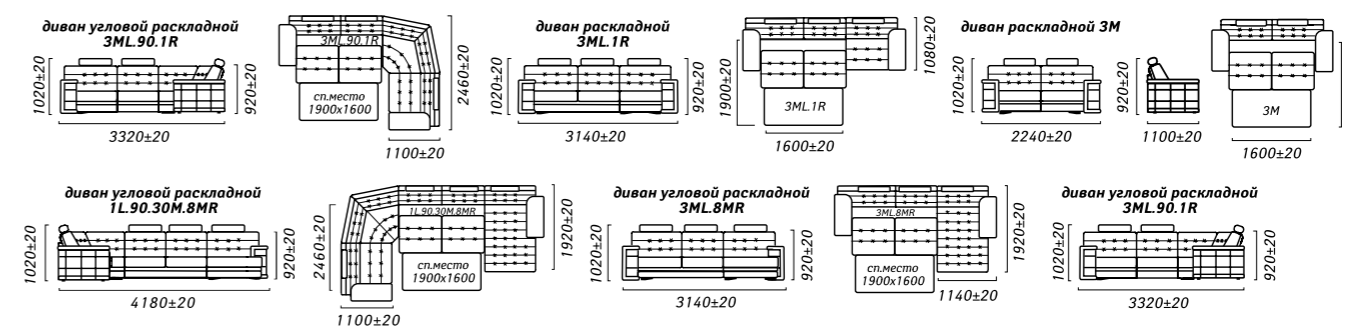

Мишель



149(0), 19 гр., 3ML.90.1AR



1232, 120 гр., 3M



674, 23 гр., 3ML.90.1AR



2340+2340, 150 гр., 3M



358, 21 гр., 8ML.30M.90.1AR



212, 19 гр., 3M



150, 19 гр., 8ML.30M.8MR



361, 21 гр., 3M



551, 21 гр., 8MR.30M.90.1AR



1037, 20 гр., 3M

Мишель



2324, 140 гр., 3ML.8MR



2345, 150 гр., 3M



414, 20 гр., 3ML.8MR



419, 20 гр., 3M



214, 19 гр., 3ML.8MR



2313, 140 гр., 3M

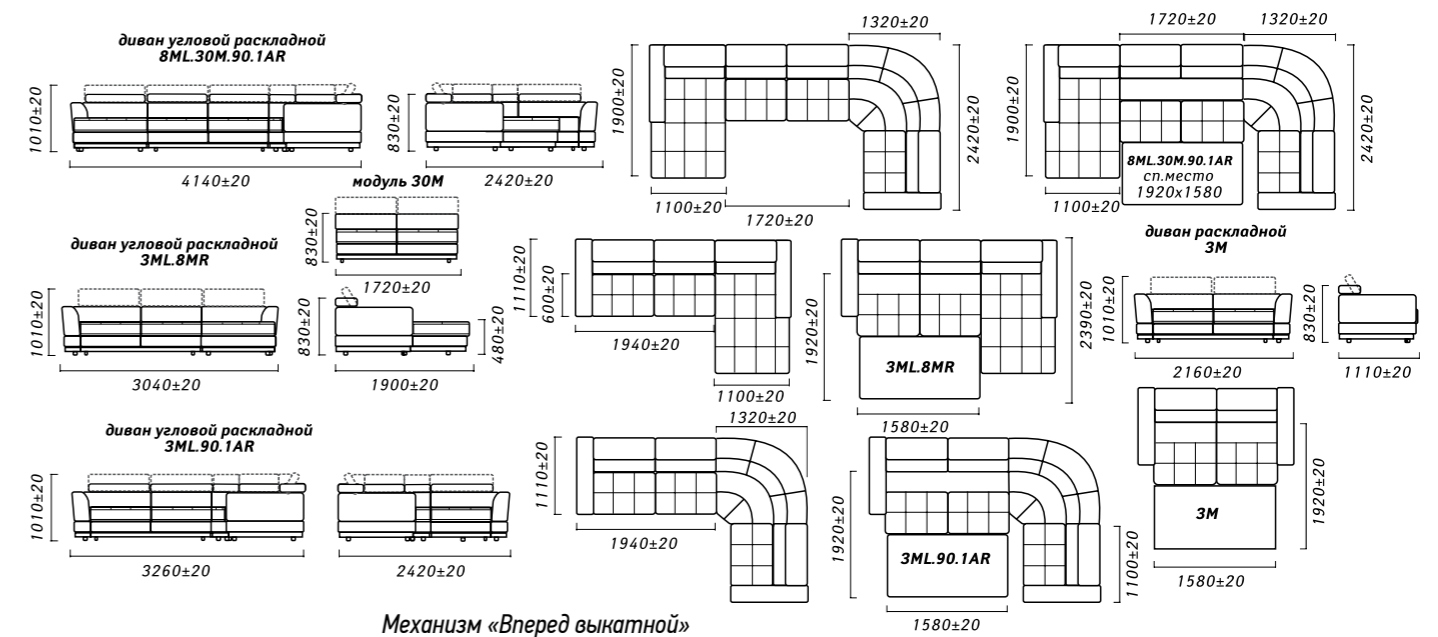



1243, 120 гр., 32



361, 21 гр., 22



2067+2067(0), 120 гр., 32



416, 20 гр., 22



30296, 23 гр., 32



412, 20 гр., 1P



743, 20 гр., 32



431, 23 гр., 22



502, 22 гр., 32



429, 23 гр., 1P



2065, 120 гр., 32



30295, 23 гр., 22



208, 19 гр., 32



3, 19 гр., 22



360, 21 гр., 32



6(0), 19 гр., 22



413, 20 гр., 32



551, 21 гр., 1P

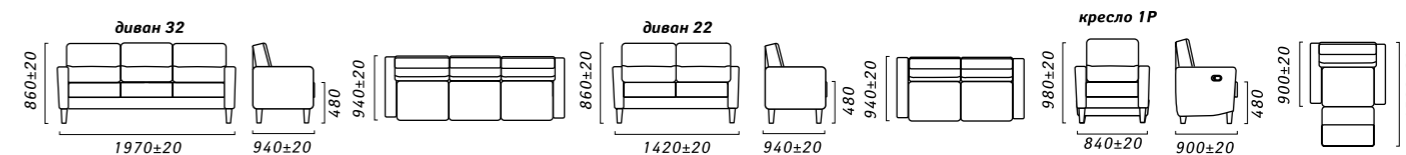

Манчестер 1



2328, 140 гр., 3ML.90.1R



2341, 150 гр., 3M



1079, 120 гр., 3ML.90.1R



212, 19 гр., 3M



2324, 140 гр., 3ML.90.1R



2340, 150 гр., 2M



3051, 140 гр., 3ML.90.1R



3343, 120 гр., 3M



661, 23 гр., 3ML.90.1R



1068+4069(0), 115 гр., 3M

Манчестер 1



493, 22 гр., 3ML.1R



8(0), 19 гр., 3M



1061, 120 гр., 3MR.1L



2313, 140 гр., 3M



10501, 120 гр., 3MR.3L



208, 19 гр., 1P

Механизм: «Седафлекс 10М», диван 2М – «IFAGRID»

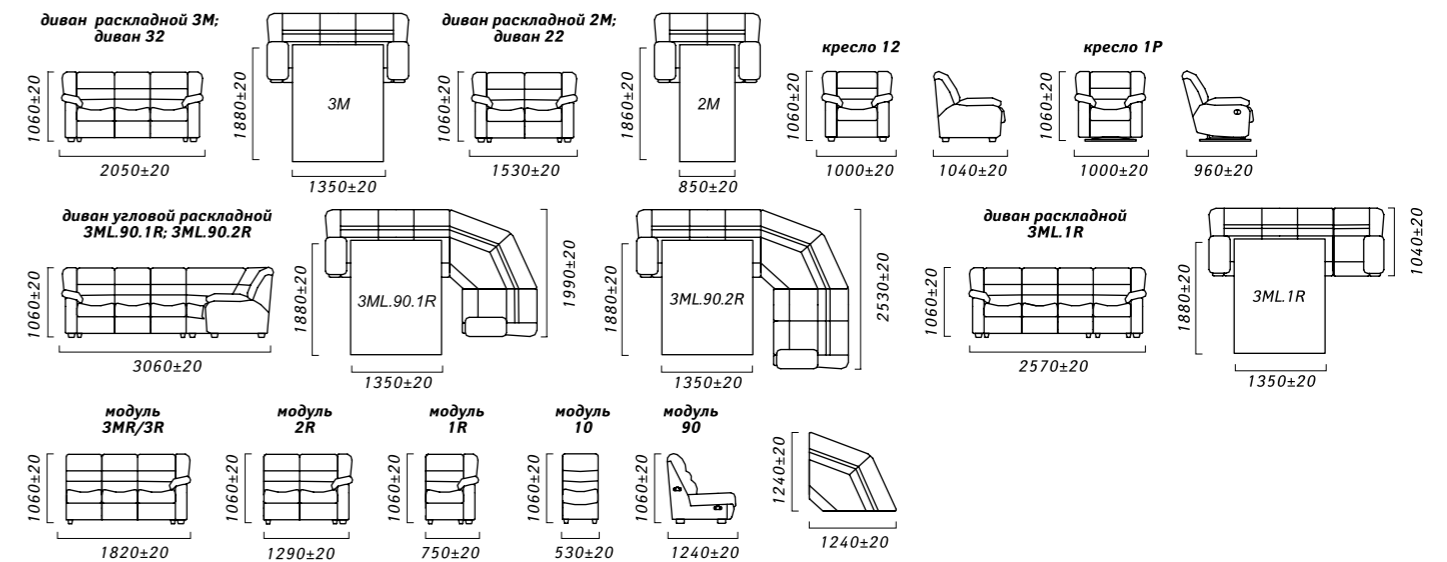

Кенни



3081, 120 гр., 4R.90.150.15EL



3087, 120 гр., 15ER.150.8L



2350, 140 гр., 4L.90.10.1ER



882, 20 гр., 15ER.150.4L



2343, 150 гр., 4R.90.150.15EL



15EL.1508R

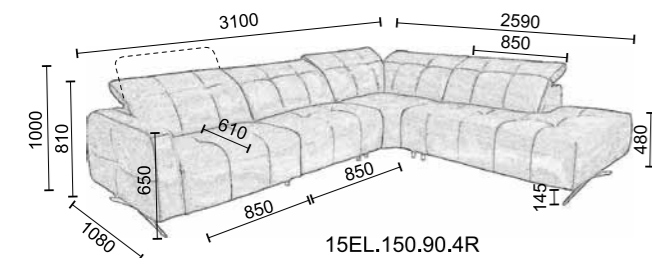

15EL.150.90.4R



2353, 140 гр., 15EL.150.90.4R

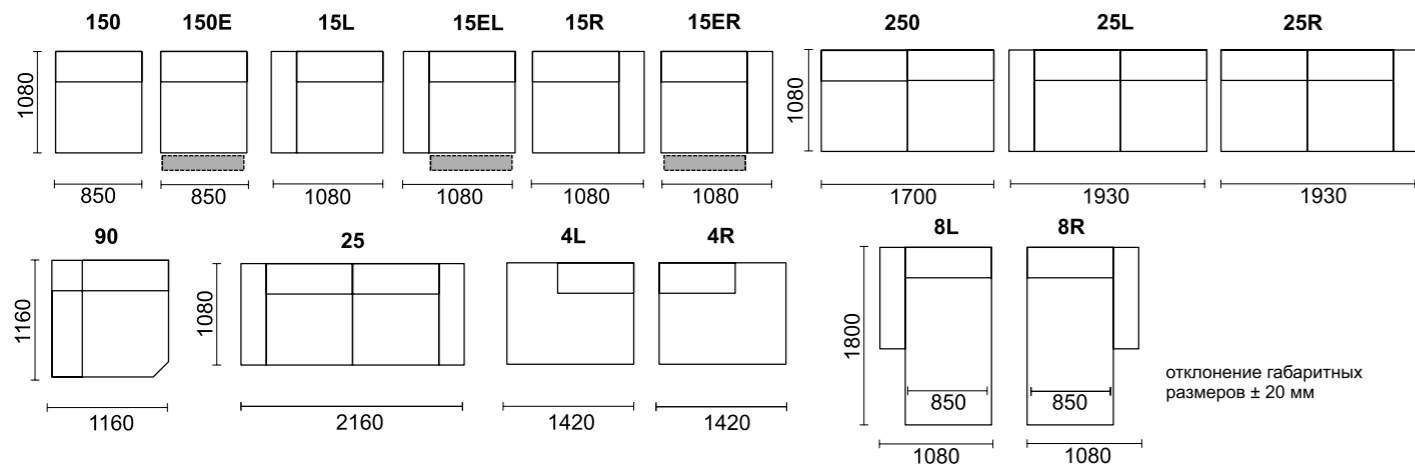

Кенни 2



3086, 120 гр., 8L.250.90.4R



34620, 27 гр., 25



3080, 120 гр., 25L.8R



3084, 120 гр., 15EL.15ER

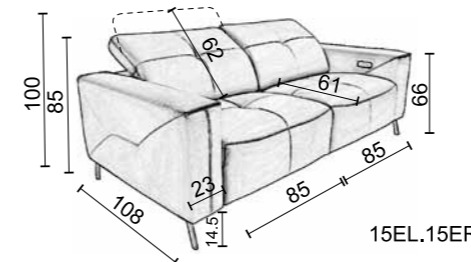

15EL.15ER

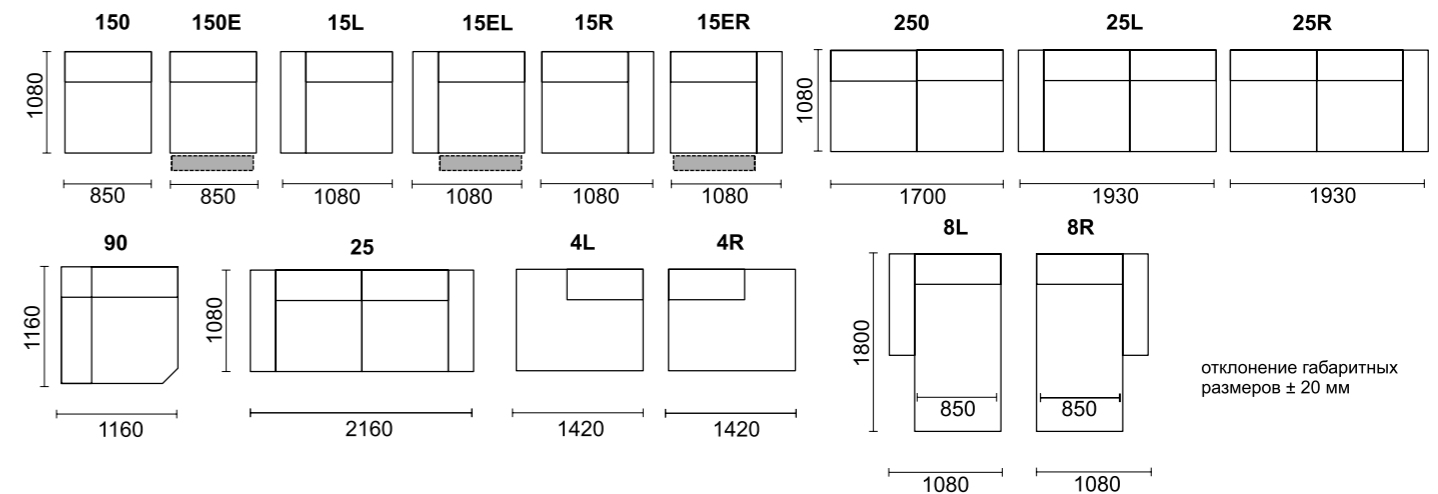

Молли



2350, 140 гр., 3L.5R



1036, 20 гр., 25L.TAB.8R



3082, 120 гр., 25L.5R



1035, 20 гр., 25L.8R

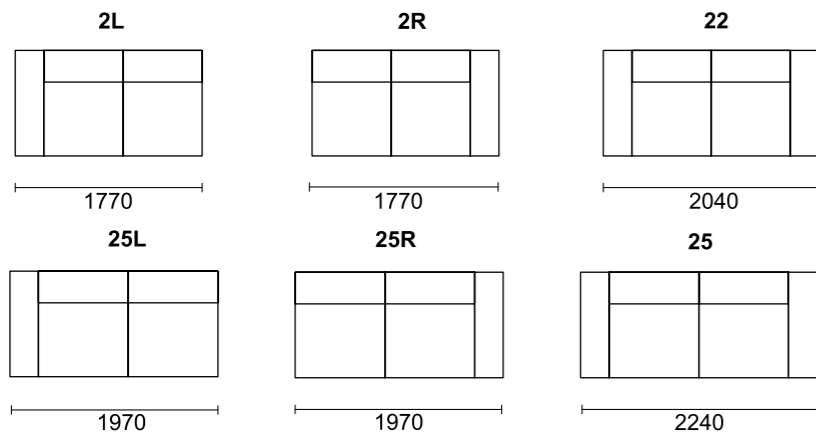
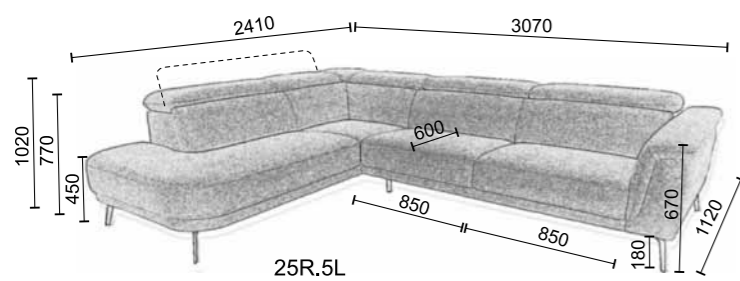

отклонение габаритных размеров ± 20 мм

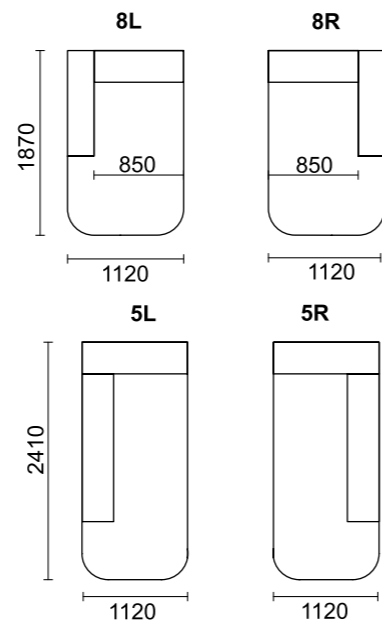

Отто



394, 22 гр., 25ML.90.10.18MR



30300, 23 гр., 25ML.90.150.18MR



30297, 23 гр., 25ML.90.150.18MR



30298, 23 гр., 25ML.90.150.18MR



30302, 23 гр., 25ML.90.150.18MR



otto_31585(0), 19 гр., 25ML.90.150.18MR



31591(0), 19 гр., 25ML.90.150.18MR

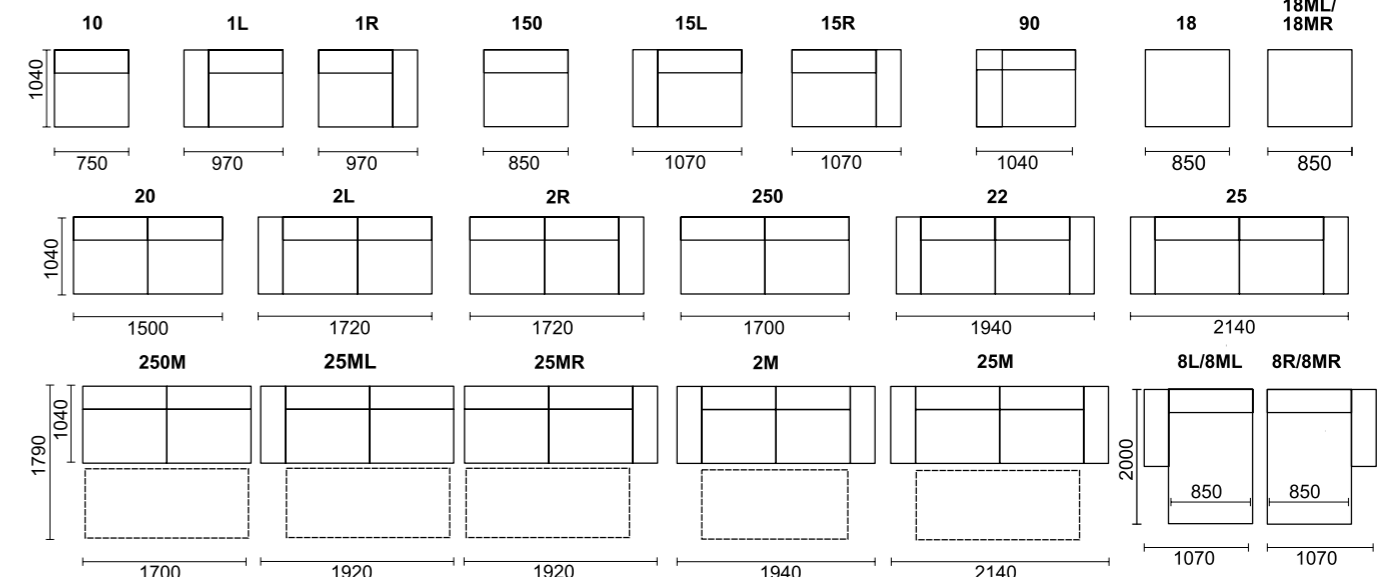
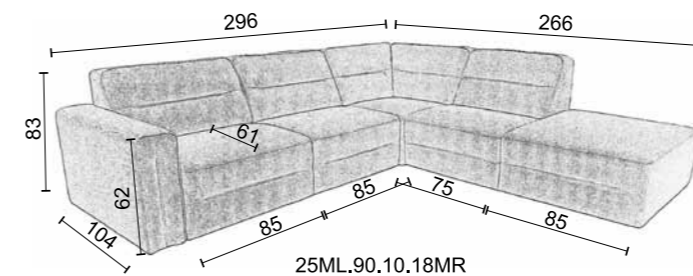

отклонение габаритных размеров ± 20 мм

Мелдон



523+523, 20 гр., 1R9010M10M904L



1039+30007, 20 гр., 1ML1MR+18



30303+30182, 23 гр., 1R.90.10M.10M.90.4L



361+361, 21 гр., 1ML1MR



662+622, 23 гр., 1L.90.10M.10M.90.4R



149(0)+149(0), 19 гр., 1ML1MR



30295+393, 23 гр., 1L9010M10M904R



215+30219, 20 гр., 1ML1MR



677+677, 23 гр., 1L.90.10M.10M.90.4R



443+30218, 20 гр., 1ML.1MR+18

Мелдон



1040+30043, 20 гр., 1ML.10M.4R



1032+30217, 20 гр., 1ML.10M.90.4R



30287+30008_1ML.10M.1R+18



550+30342, 21 гр., 1ML10M901R



31035+30026, 19 гр., 1ML.10M.1MR



413+412, 20 гр., 1ML10M901R



30283+30292(0), 22 гр., 10ML10M1R



364+364, 21 гр., 1ML10M901R



30293(0)+30293, 19 гр., 1ML.10M.10M.1MR



551+552, 21 гр., 1ML10M904R

Мелдон



742+30219, 20 гр., 1ML.10M.1MR



513+513+20 гр., 1ML.10M.90.4R



30126+34970, 20 гр., 1ML.10M.1MR



990+30274, 19 гр., 1ML.10M.90.4R



30286+30185, 22 гр., 1ML.10M.10.10.1R



212+30218, 20 гр., 1ML.1MR

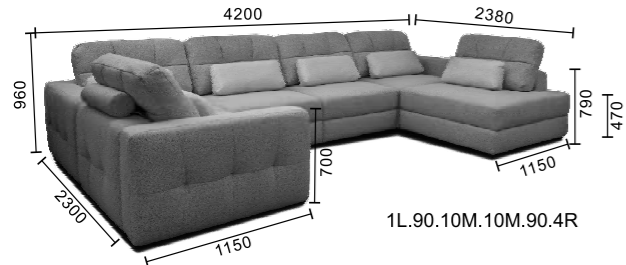

1L.90.10M.10M.90.4R

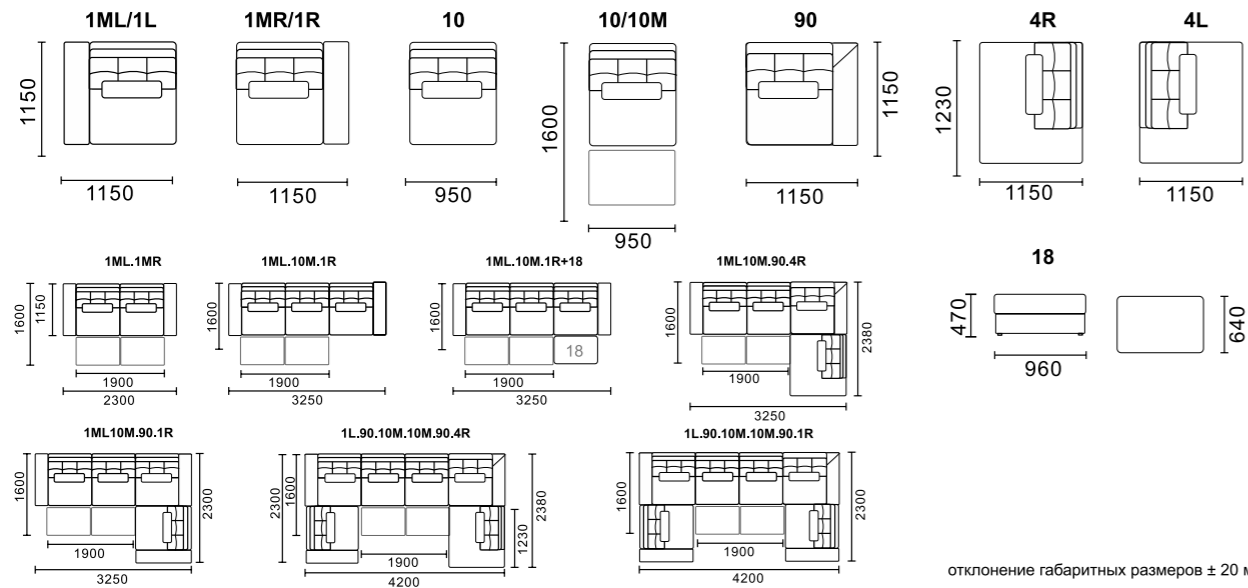

отклонение габаритных размеров ± 20 мм

Сохо



31502, 19 гр., .



394, 22 гр., 1EL.10.8MR



395, 22 гр., 1EL.10.8MR



34562, 24 гр., 1EL.10.8MR



753, 20 гр., 2MR.8MPL

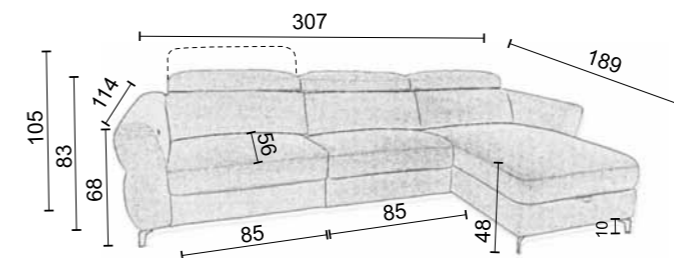

15EL.150.8MR

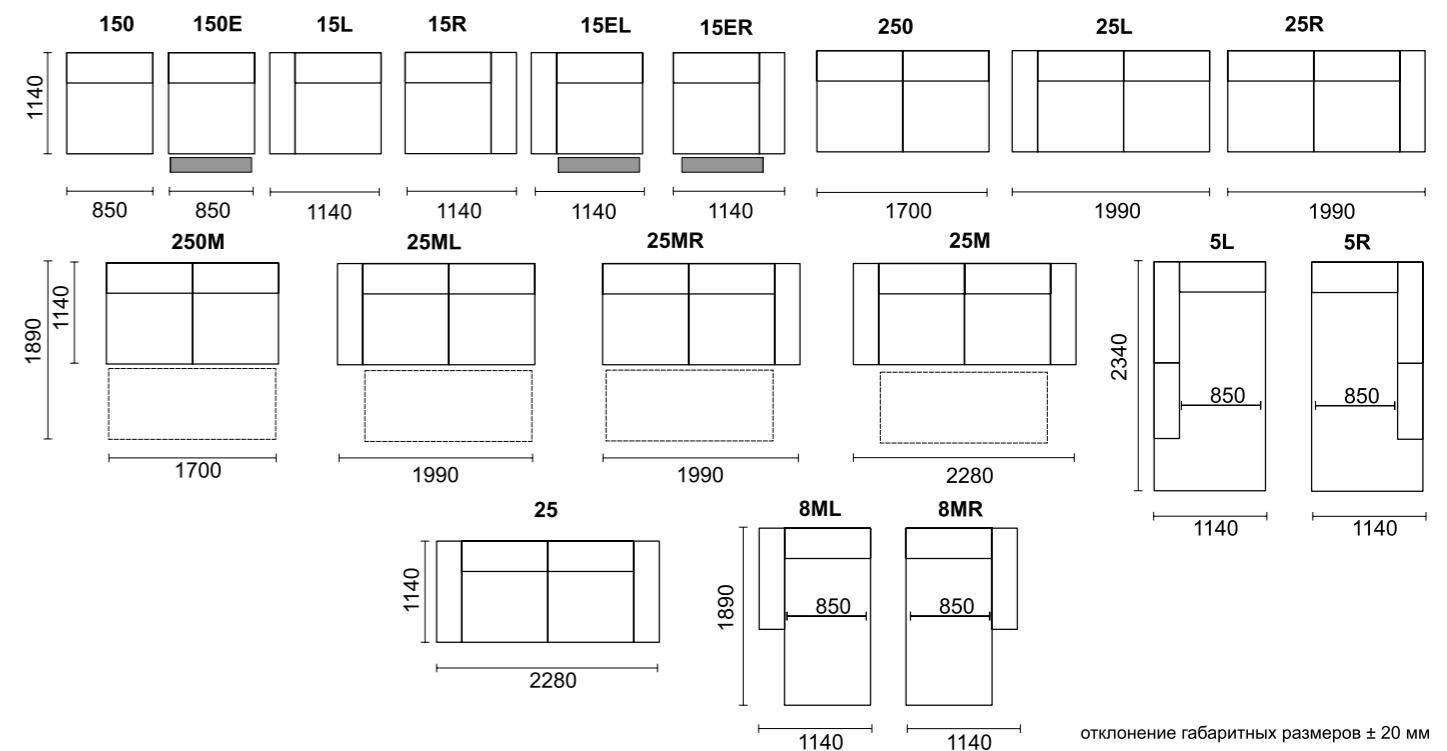

отклонение габаритных размеров ± 20 мм

Бейкер



30318, 22 гр., 8R.150+30221, 24 гр., 4L



31036, 19 гр., 4L8R



148(0), 19 гр., 15L150904R



364, 21 гр., 15L150904R



413, 20 гр., 15L150904R



483, 19 гр., 15L150904R



477, 19 гр., 15L150904R



675_15L.150.90.4R



30282, 22 гр., 15L150904R



31510, 19 гр., 15L150904R

Бейкер



30286, 22 гр., 15L150904R



30314, 19 гр., 15L150904R

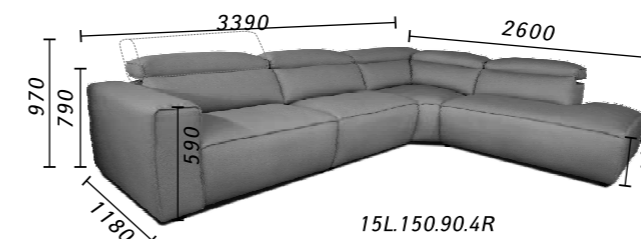

15L.150.90.4R

отклонение габаритных размеров ± 20 мм

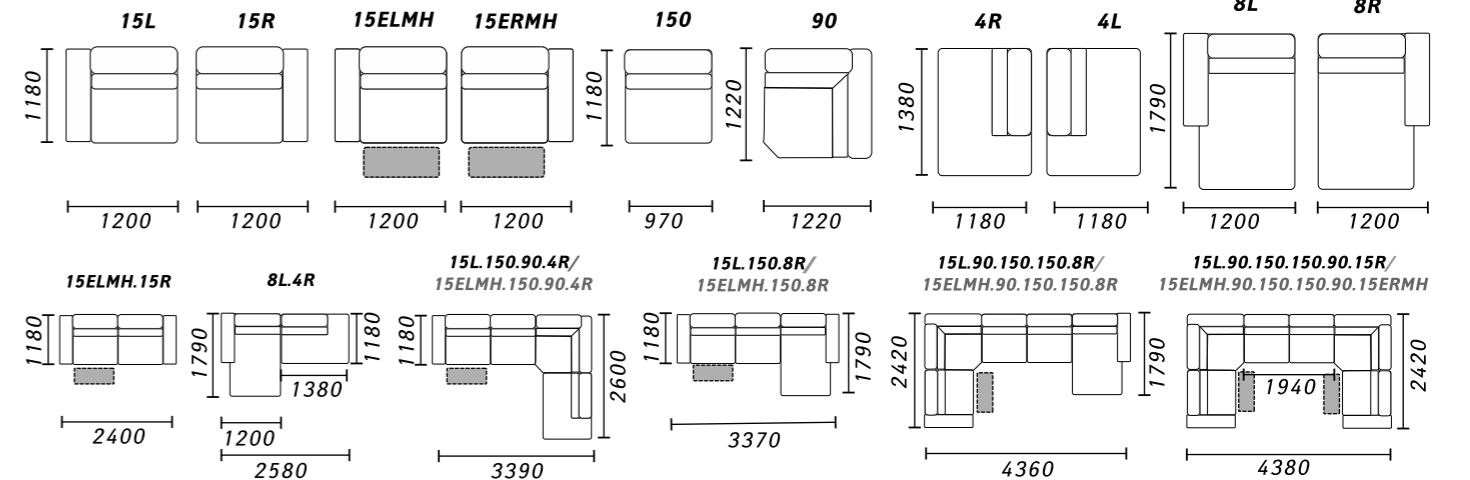

Леруа



30317+30219+30302, 22 гр., 2L.90.1R



30290(0)+30290+30290, 19 гр., 2L.1R+18



514+514+31594, 20 гр., 1L.90.20.90.1R



30291(0)+30290+30291(0), 19 гр., 1L9020901R



250+250+250, 20 гр., 22



30297+30297+30290, 23 гр., 22

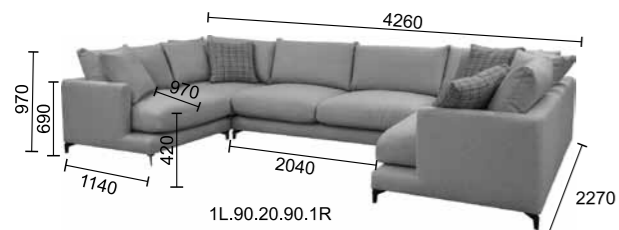

1L.90.20.90.1R



44+44+44, 19 гр., 22

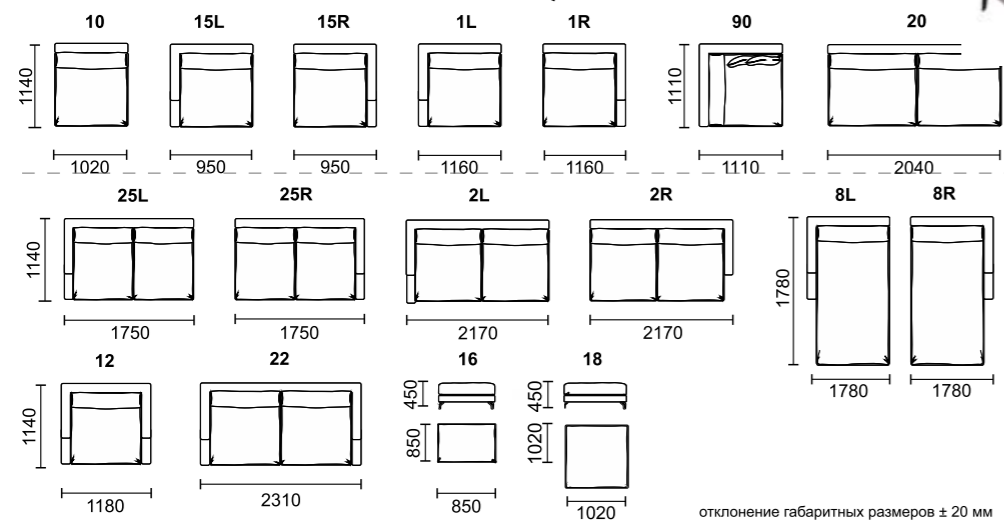

отклонение габаритных размеров ± 20 мм

Колабус



30296, 23 гр., 1L101R+18



1033, 20 гр., 1L.1R



250, 20 гр., 1L.10.1R+18



30132, 20 гр., 1L.10.1R



30126, 20 гр., 1L.10.1R+18



kolambus_48, 19 гр., 1L.10.1R

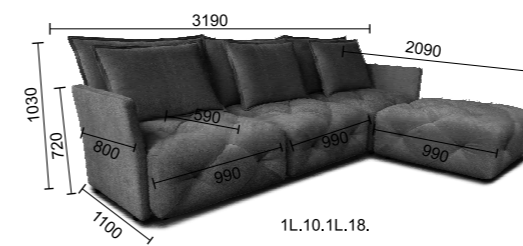

1L.10.1L.18.

отклонение габаритных размеров ±20 мм



30127, 20 гр., 1L.10.1R+18

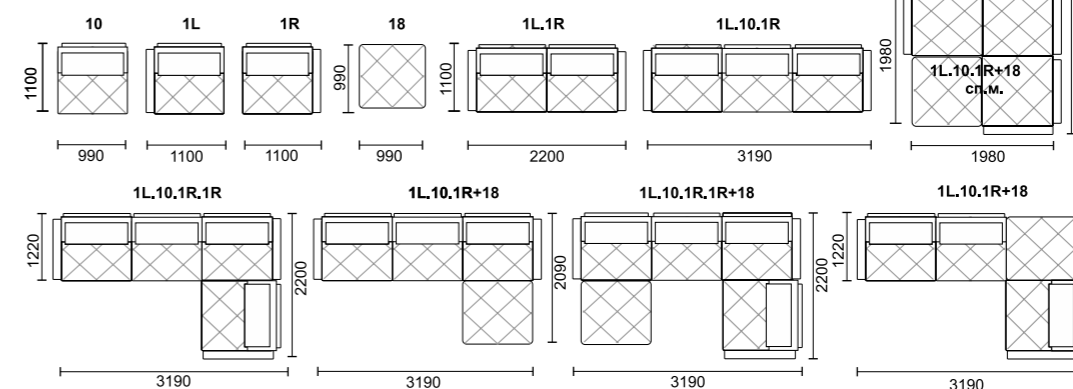



2005, 120 гр., 3ML.90.1R



1241, 120 гр., 3M



2312, 140 гр., 3ML.90.1R



429, 23 гр., 3M



1079, 120 гр., 3ML.90.1R



502+502, 22 гр., 3M_P43



2341, 150 гр., 3ML10901R



428, 23 гр., 3M



1060, 120 гр., 3ML.90.1R



2350, 140 гр., 3M



3051, 140 гр., 3ML.90.1R



2343, 150 гр., 3M



552+552, 21 гр., 3ML.90.1R_sl k



royal_30210+30210(0), 26 гр., 3M



2350, 140 гр., 3M



2005, 120 гр., 12



1068, 120 гр., 18

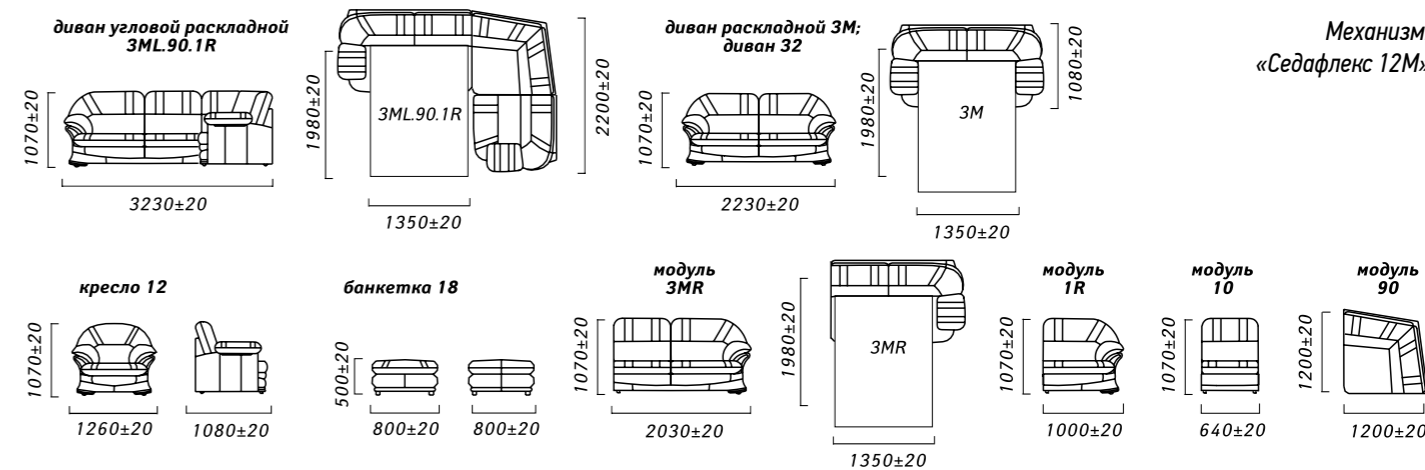



1242, 120 гр., 3М



517, 20 гр., 3М



2324, 140 гр., 32



429+429, 23 гр., 2М



2067, 120 гр., 32



2341, 150 гр., 2М



2345, 150 гр., 3М



412+412, 20 гр., 2М



2069, 120 гр., 32



425+425, 23 гр., 2М



860, 20 гр., 3М



862, 20 гр., 2М



1079, 120 гр., 3М



6(0), 19 гр., 2М



148, 19 гр., 3М



207, 19 гр., 2М



358+360, 21 гр., 3М



210+211, 19 гр., 2М

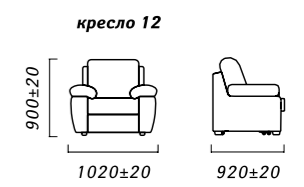
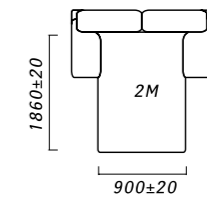
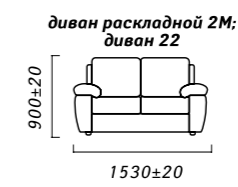
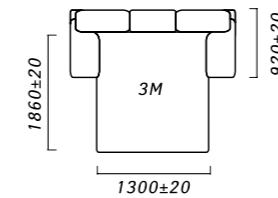
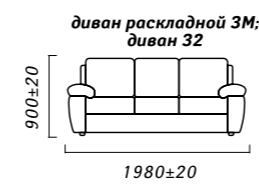

Механизм: «Французская раскладушка»



501, 22 гр., 3ML.90.1R



2352, 140 гр., 3M



2065, 120 гр., 3ML.90.1R



429, 23 гр., 3M



1062, 120 гр., 3ML.90.1R



2342, 150 гр., 3M



500, 22 гр., 3ML.90.1R



2065, 120 гр., 3M



1068, 120 гр., 3ML.90.1R



947, 19 гр., 3M



213, 19 гр., 3M



429, 23 гр., 3M



443+443, 20 гр., 3M



552+552, 21 гр., 3M



556, 21 гр., 3M



654+654, 19 гр., 3M



979, 19 гр., 3M



977, 19 гр., 3M

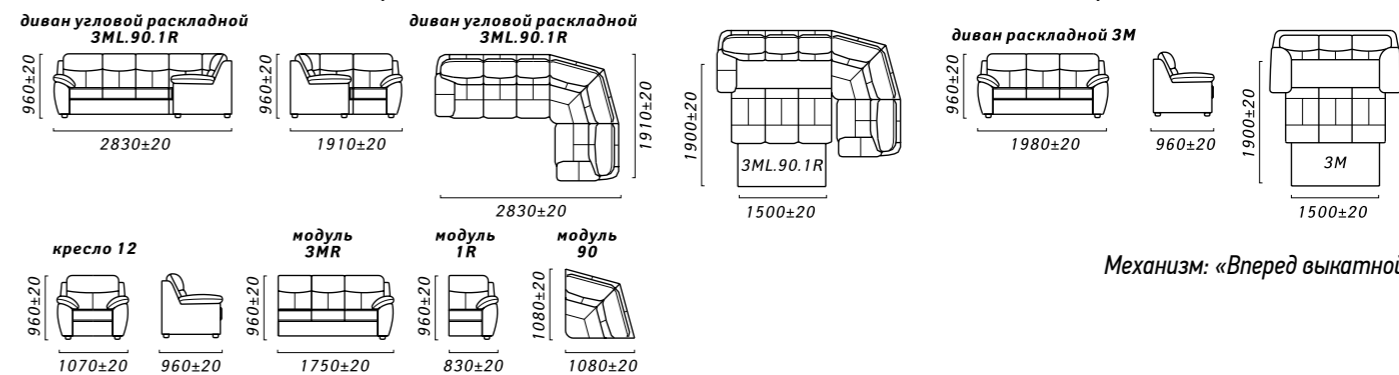

Люксор



502+502, 22 гр., 3ML1R



31589+426, 19 гр., 3M



417+412, 20 гр., 3ML.90.1R



1242+1242+426, 120 гр., 3M



990+980, 19 гр., 3ML.90.1R



212+212, 19 гр., 3M



980+980, 19 гр., 3ML.90.1R



2001+362, 120 гр., 3M



207+208, 19 гр., 3ML.90.1R



2345+208, 150 гр., 3M

Люксор

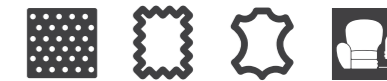

1068+208, 120 гр., 3ML.8MR



30299+30299, 23 гр., 3M



2341, 150 гр., 3ML.8MR



30286+551, 22 гр., 3M



213+213, 19 гр., 3ML.8MR



416+416, 20 гр., 3M



498+30166, 22 гр., 3ML.8MR



676+676, 23 гр., 3M

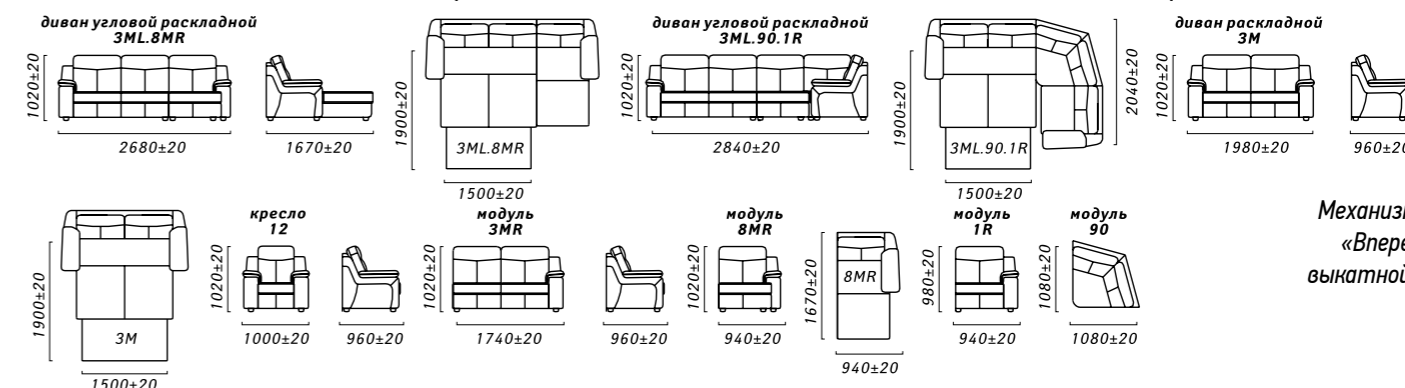

Механизм:
«Вперед
выкатной»



2328, 140 гр., 3ML.90.1R



3343, 120 гр., 22



1060, 120 гр., 3ML.90.1R



10501, 120 гр., 22



556, 21 гр., 3L.10.90.2R



211_19 гр_12



563, 21 гр., 3ML.90.1R



2005, 120 гр., 22



422, 23 гр., 3L903R



2324, 140 гр., 18



1068, 120 гр., 3M



2313, 140 гр., 3M



9(0), 19 гр., 3M



149(0), 19 гр., 3M



362, 21 гр., 32



431, 23 гр., 3M



654, 19 гр., 3M



555, 21 гр., 3M

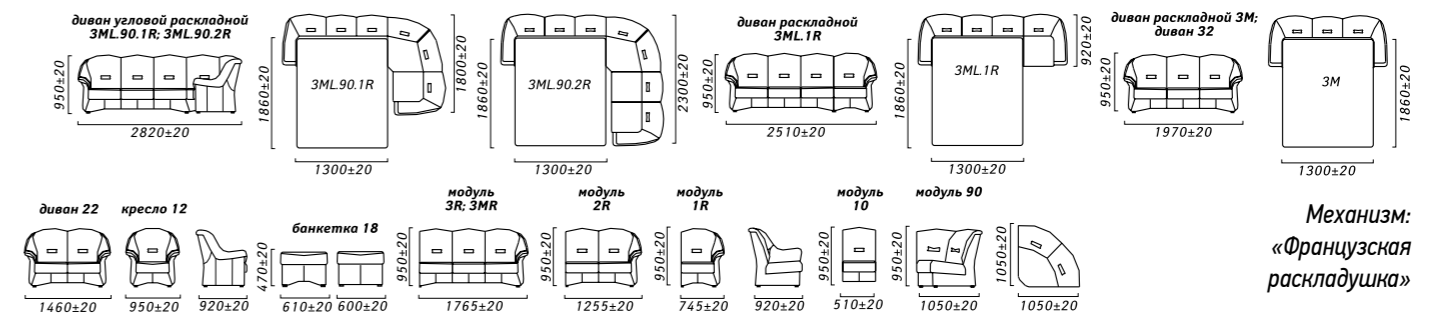

Дельта



2343, 150 гр., 3М



2340, 150 гр., 32



1060, 120 гр., 3М



1062, 120 гр., 3М



501, 22 гр., 3М



557, 21 гр., 3М



1068, 120 гр., 3М



1061, 120 гр., 3М



429, 23 гр., 3М



2005+120gr_3М

Дельта



2067, 120 гр., 3М_E50N10



493, 22 гр., 3М



10501, 120 гр., 3М



654, 19 гр., 2М_E50A



429, 23 гр., 3М



659, 19 гр., 22



2010, 120 гр., 3М



2343, 150 гр., 12

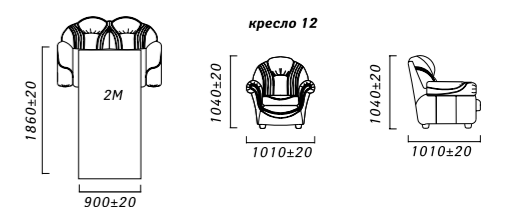
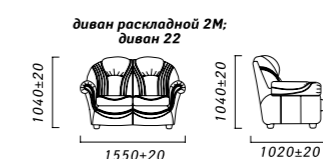
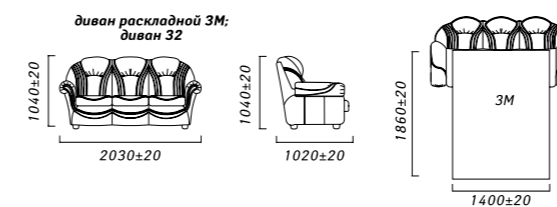

Изабель Royal



2310, 140 гр., 3ML.90.1R



611+611, 22 гр., 2M



1060, 120 гр., 3ML.90.1R



1061, 120 гр., 22



royal_816+816(0), 24 гр., 3ML.90.1R



royal_30214+30214(0), 26 гр., 22



royal_30213+30213(0), 26 гр., 3ML.90.1R



607+607, 24 гр., 22



1079, 120 гр., 3MR1L



502+502, 22 гр., 2M

Изабель



2067, 120 гр., 3M



2065, 120 гр., 3M



2352, 140 гр., 3M



565+565_21gr



royal_913+913(0)_21gr



royal_911+911(0), 21 гр., 3M



501, 22 гр., 3MR1L



royal_30215+30215(0), 26 гр., 12

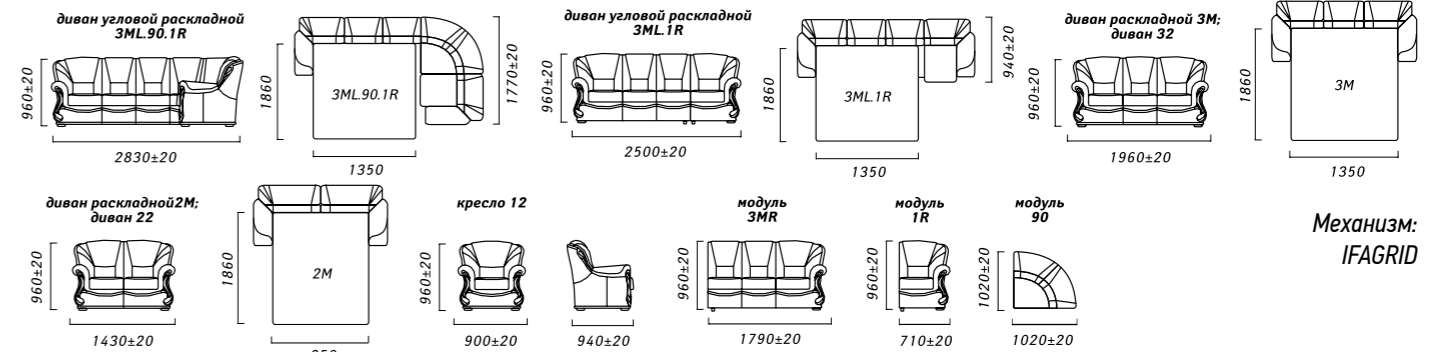

Механизм:
IFAGRID

Консул-2020 (-С)



слоновая кость с золочением



120 гр., 1060, дуб рустикаль с патиной



140 гр., 3051, слоновая кость с серебром



120 гр., 2001, дуб рустикаль с патиной



120 гр., 1068, античная бронза

Консул-2020 (-С)



140 гр., 2312+2312(0), табак



120 гр., 1068, рустикаль



140 гр., 2020, слоновая кость с золочением



120 гр., 1079, слоновая кость (В-2), золото



слоновая кость с золочением



120 гр., 1061, дуб рустикаль

Механизм: «Трансформер»

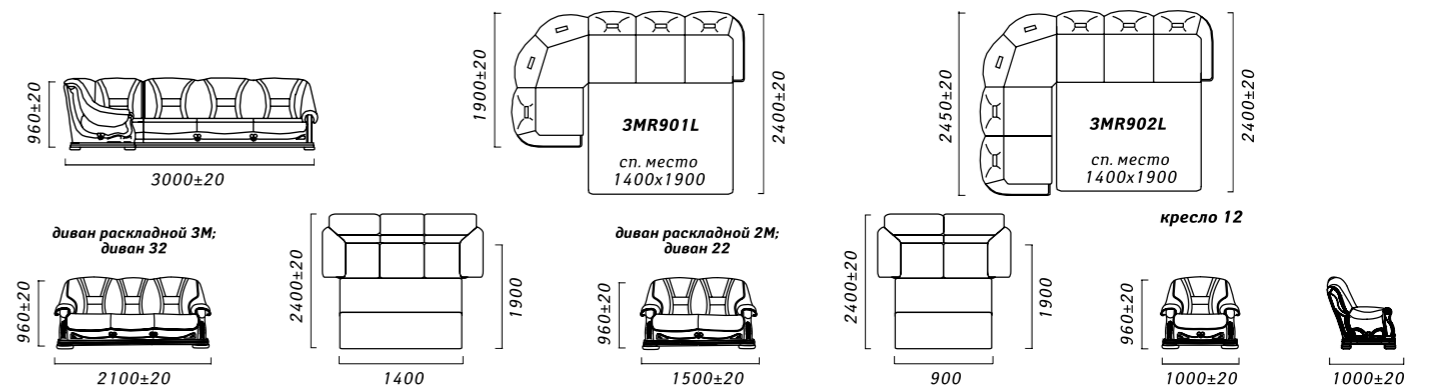

Консул-24



Кембридж Сити



1079, 120 гр.



1242, 120 гр.



1061, 120 гр.



1068, 120 гр.



31509, 19 гр.



31511, 19 гр.



304, 19 гр.



305, 19 гр.



306, 19 гр.

Механизм: «Трансформер»

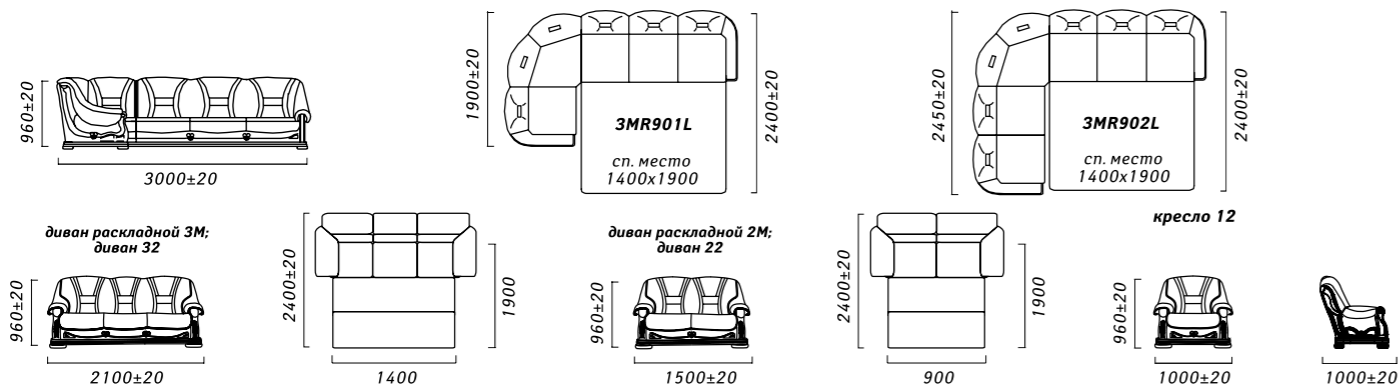

Механизм: «Тик-так»

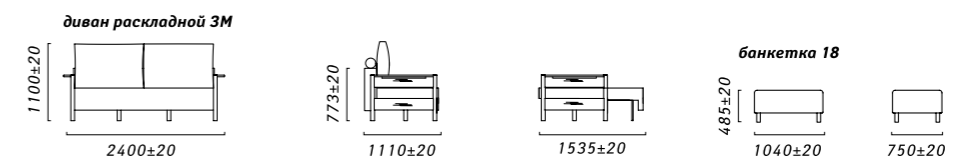

Болеро



744, 20 гр., 2ML.8MR



995, 19 гр., 2ML.8MR



30295, 23 гр., 2ML.8MR



30315, 22 гр., 2ML.8MR



519, 20 гр., 2ML.8MR



1034, 20 гр., 2ML.8MR



549, 21 гр., 2ML.8MR



658, 19 гр., 2ML.8MR



674, 23 гр., 2ML.8MR



672, 23 гр., 2ML.8MR

Болеро



30132, 20 гр., 2ML.8MR



1032, 20 гр., 2ML.8MR



414, 20 гр., 2ML.8MR



985, 19 гр., 2ML.8MR



770, 19 гр., 2ML.8MR



31578(0), 19 гр., 2ML.8MR



30177, 20 гр., 2ML.8MR



654, 19 гр., 2ML.8MR

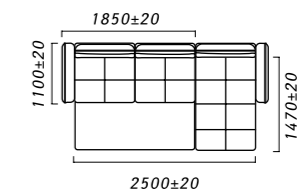
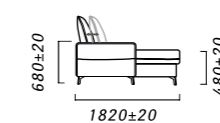

Механизм
«Дельфин»

Малибу



9(0)+1, 19 гр., 3-М+8М+03+03



149+149, 19 гр., 30М+8М+03



412+412, 20 гр., 30М+8М+03+03



413+211, 20 гр., 30М+8М+03+03



414+417, 20 гр., 30М+8М+03+03



520+520, 20 гр., 30М+8М+03+03



523+519, 20 гр., 30М+8М+03+03



558+435, 21 гр., 30М+8М+03+03



946+365, 19 гр., 30М+8М+03+03



519+519, 20 гр., 30М+8М+03+03

Малибу



485+481, 19 гр., 30М+8М+90+10+03+03



151+151, 19 гр., 30М+8М+03+03



1020+1026, 19 гр., 30М+90+10+03+03



31508+31508, 19 гр., 30М9010+03+03



984+984, 19 гр., 30М+8М+8М+03+03



31503+215, 19 гр., 30М8М+03+03

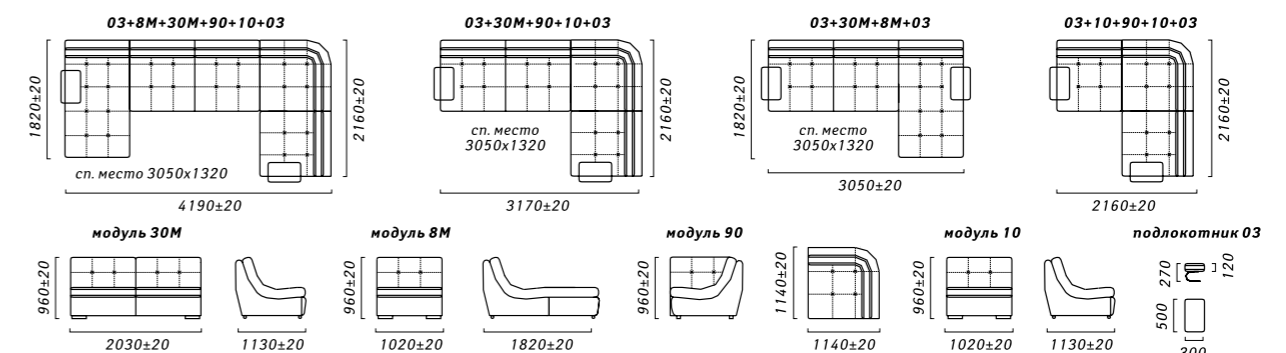

Механизм:
«Пума»

Κορφυ



402, 22 гр., 25L.6R



31220, 19 гр., 25L6R



Korfu_214, 19 гр., 25L.6R



31581(0), 19 гр., 25L6R



148, 19 гр., 25L6R



210, 19 гр., 25L6R



211, 19 гр., 25L.6R



212, 19 гр., 25L6R



424, 23 гр., 25L.6R



435, 23 гр., 25L.6R

Κορφυ



959, 19 гр., 25L.6R



986, 19 гр., 25L.6R



554, 21 гр., 25L.6R



553, 21 гр., 25L6R



513, 20 гр., 25L6R



557, 21 гр., 25L.6R



658, 19 гр., 25L6R



1018, 18 гр., 25L6R

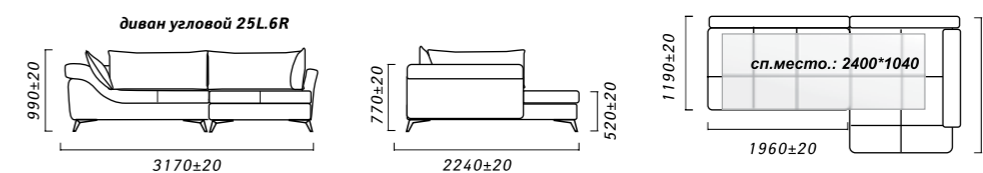

Бали



30330+30289+30317, 26 гр., 3М



479+31594+480, 19 гр., 3ML4R



30300+30007+30297, 23 гр., 3М



419+909+449, 20 гр., 3ML4R



30303+30131+30134, 23 гр., 3М



9(0)+8(0)+6(0), 19 гр., 3ML4R



981+702+712, 19 гр., 3М



3+960+954, 19 гр., 4L30M4R



520+813+671, 20 гр., 3М



502+30210+30210(0), 22 гр., 3ML4R

Бали



1033+30315+30295, 20 гр., 4L30M4R



1011+911(0)+911, 18 гр., 3М



30334+30330+30289, 26 гр., 4L30M4R



983+814+981, 20 гр., 3М



659+30131+31594, 19 гр., 4L.30M.4R



30175+30347+30175, 20 гр., 3М

Механизм Living Bed

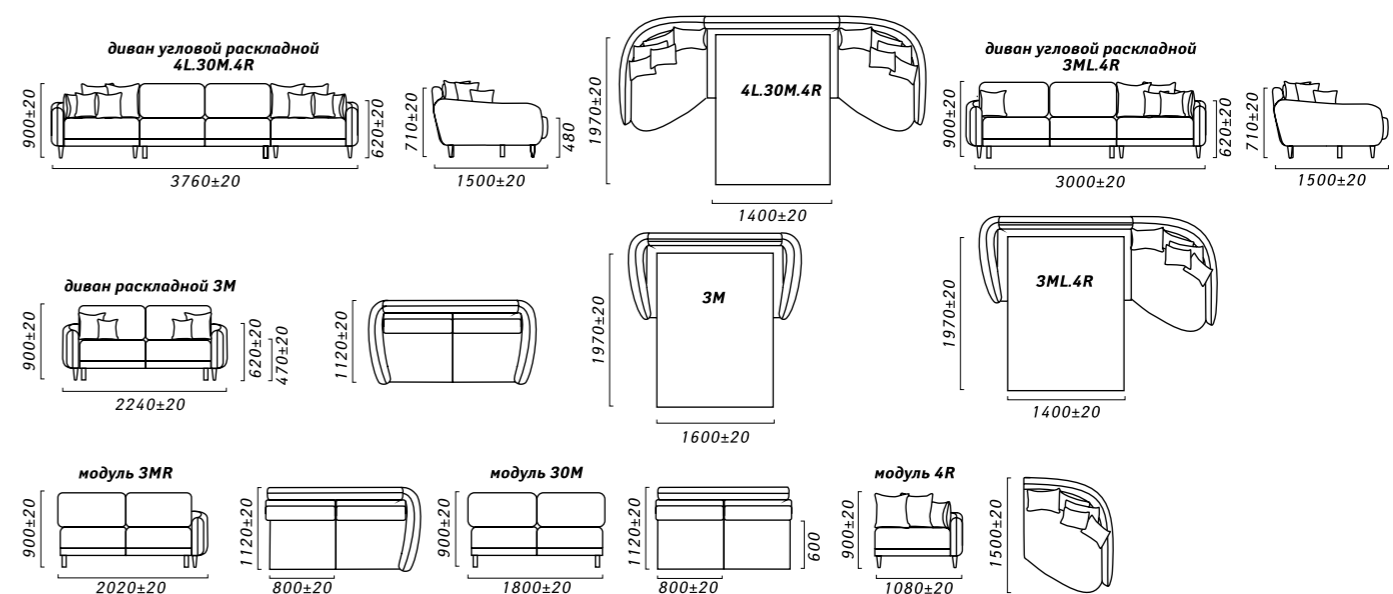

Оливер



864, 20 гр., 2ML.8MR



860, 20 гр., 2ML.8MR



5(0), 19 гр., 2ML.8MR



30301, 23 гр., 2ML.8MR



30137, 20 гр., 2ML.8MR



214, 19 гр., 2ML.8MR



417, 20 гр., 2ML.8MR



449, 20 гр., 2ML.8MR



435, 23 гр., 2ML.8MR



150, 19 гр., 2ML.8MR

Оливер



31222, 19 гр., 2ML.8MR



31221, 19 гр., 2ML.8MR



477, 19 гр., 2ML.8MR



479, 19 гр., 2ML.8MR



654, 19 гр., 2ML.8MR



675, 24 гр., 2ML.8MR



800(0), 19 гр., 2ML.8MR



979, 19 гр., 2ML.8MR

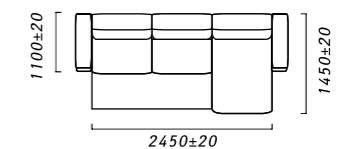
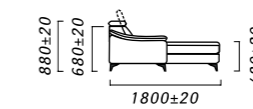
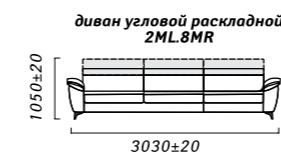

Механизм
«Дельфин»

Магнат



19 гр., 300, 3ML.90.1R



19 гр., 306, 3M



19 гр., Infinity4, 3ML902R



22 гр., 499, 3M



19 гр., 304, 3ML902R



19 гр., Tobago12, 3ML902R

Механизм:
«Французская раскладушка»

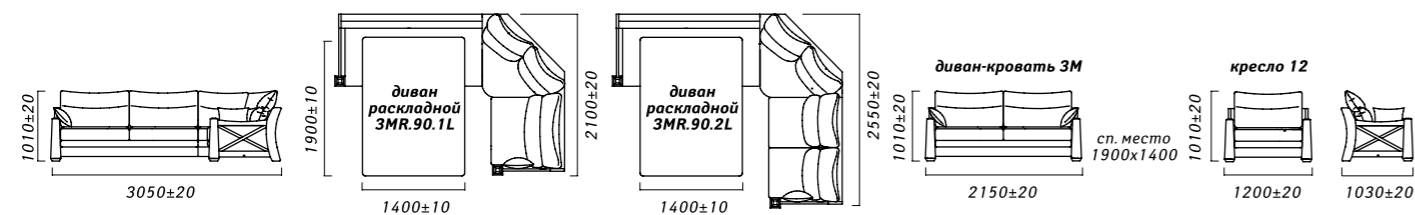

Jamaica Ямайка



21 гр., 558, 03+10+90+13+19



22 гр., 493, 03+10+10+90+18



22 гр., 499, 03+10+13+90+18



22 гр., 499, 13+90+13+19



21 гр., 560, 03+10+90+13+19



22 гр., 35323, 03+10+10+03



22 гр., 35085, 03+10+90+13+19

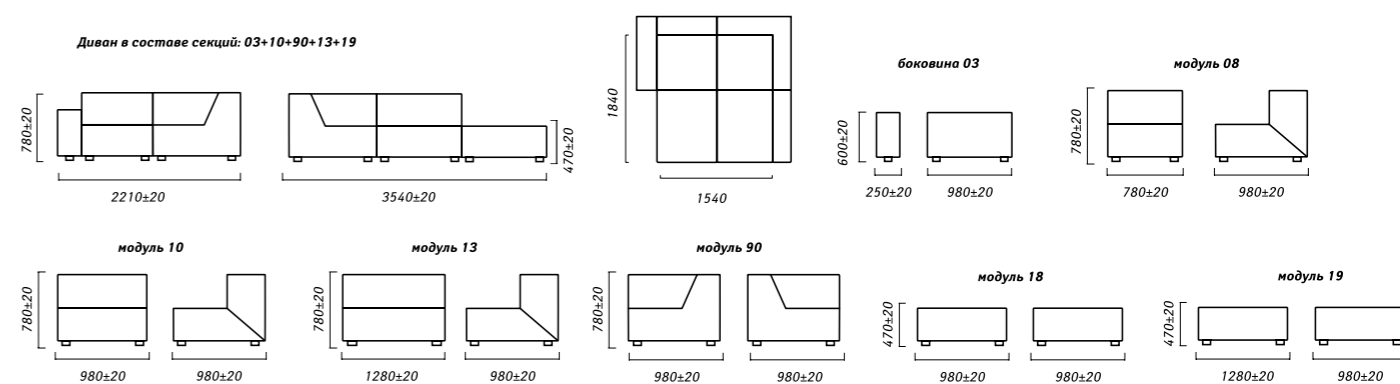

Алан



30300+30007, 23 гр., 4ML90.2MR



1032+30217, 20 гр., 2ML.90.4MR



1040+30054, 20 гр., 2ML.90.4ML



30298+30298, 23 гр., 2ML.90.4MR



5+5, 19 гр., 2ML90.4M



45+45, 19 гр., 4ML.90.2MR



46, 11 гр., 2ML.90.4MR



30299+30299, 23 гр., 2ML.90.4MR

Механизм «Дельфин»

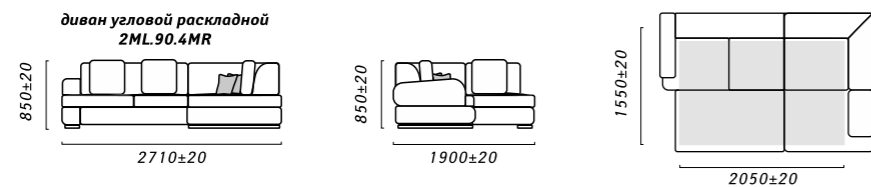

Самос



1039, 20 гр., 2ML.8MR



1040, 20 гр., 2ML.8MR



31033, 19 гр., 2ML.8MR



31034_19_2ML.6MR



31036, 19 гр., 2ML.6MR



31578(0), 19 гр., 2ML.8MR



746, 20 гр., 2ML.8MR



1001, 19 гр., 2ML.8MR

Механизм «Тик-так»

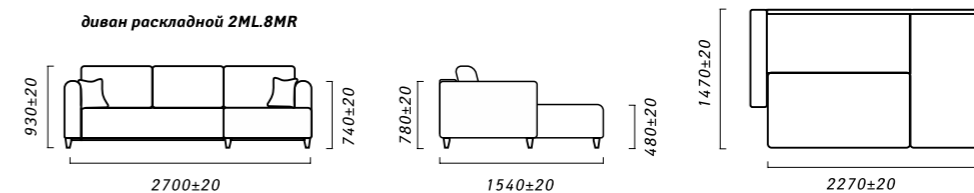



31590(0)+30057, 19 гр., 1ML10M8MR



30297+30007, 23 гр., 1ML1MR



31587(0)+30050, 19 гр., 1ML10M8MR



721+719, 19 гр., 1ML1MR



714+720, 19 гр., 1ML10M1MR



31588(0)+815, 20 гр., 1ML1MR



30176+711, 20 гр., 1ML10M8MR



31583(0)+632, 19 гр., 1ML1MR



987+31594, 19 гр., 1ML10M8MR



654+710, 19 гр., 1ML8MR



1036+30218, 20 гр., 1ML.10M.8MR



1033+35422, 21 гр., 1ML1MR



999+30029, 19 гр., 1ML.10M.1MR



797(0)+609, 19 гр., 1ML.1MR



150+712, 19 гр., 1ML108MR



482+31595, 19 гр., 1ML8MR



6(0)+31594, 19 гр., 1ML10M8MR



768+31594, 19 гр., 1ML8MR

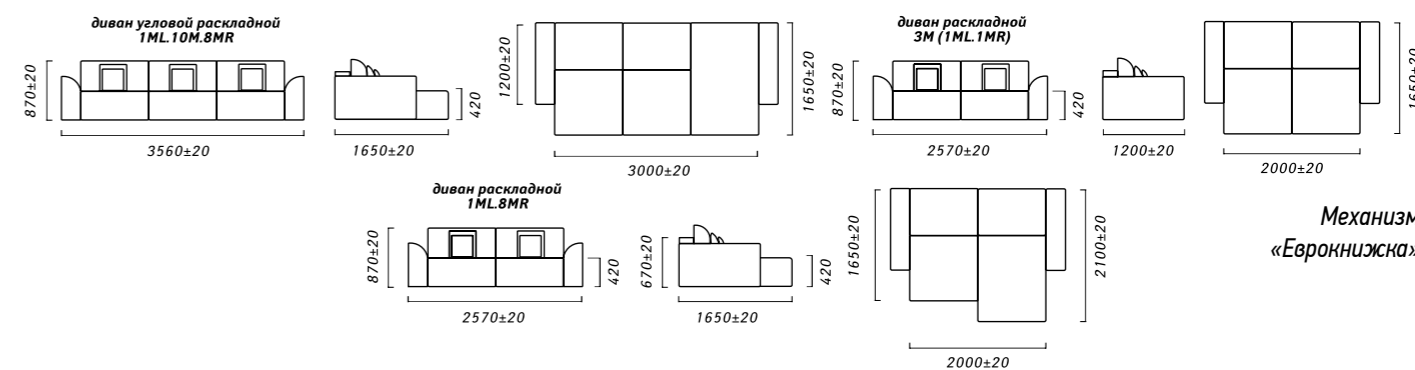

Нью-Йорк



659+659+659, 19 гр., 2ML.6MR



31228+30050+31227, 19 гр., 3M



211+211+211, 19 гр., 3ML6MR



212+30281+30274, 19 гр.,



557+734+734, 21 гр., 3ML6MR



30291(0)+30290(0)+30293, 19 гр., 3M



517+766+30259, 20 гр., 3ML6MR.



402+393+30008, 22 гр., 3M



30160+813+30170, 20 гр., 3ML6MR



657+31117+31116, 19 гр., 3M

Нью-Йорк



989+980+31596, 19 гр., 2ML.6MR



30293(0)+30290(0)+30290, 19 гр., 3M



31582(0)+31587(0)+611, 19 гр., 2ML.6MR



31506+31505+711, 19 гр., 3M



558+558+558, 21 гр., 2ML6ML



478+711+485, 19 гр., 3M



246+30343+953, 20 гр., 2ML.6MR



6(0), 19 гр., 3M
Механизм: «Тик-так»

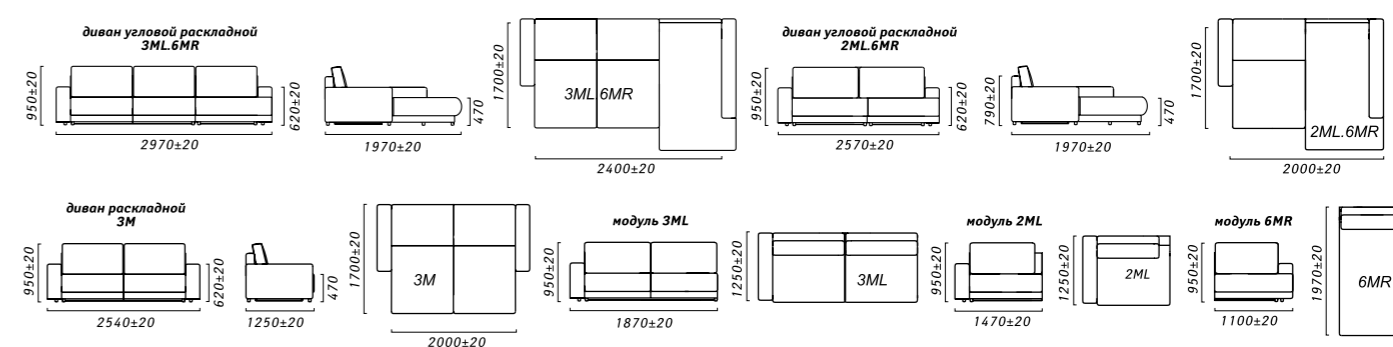

Дориан 2



1037+30028, 20 гр., 2ML.8MR



714+715, 19 гр., 3M



30177+609, 20 гр., 3ML8R



866(0)+30029, 20 гр., 3M



9(0)+710, 19 гр., 2ML.8MR



994+30043, 19 гр., 3M



413+412, 20 гр., 3ML8R



913(0)+913, 21 гр., 3M



3(0)+3(0), 19 гр., 2ML.8MR



394+398, 22 гр., 3M

Дориан 2



1026(0)+908(0), 19 гр., 2ML8MR



996+30029, 19 гр., 3M



984+911, 19 гр., 2ML.8MR



30302+30314, 23 гр., 3M



31583(0)+31582(0), 19 гр., 2ML.8MR



450+30179, 20 гр., 3M



149+149(0), 19 гр., 2ML.8MR



400+393, 22 гр., 3M

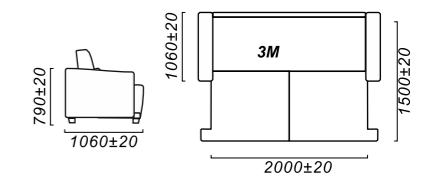
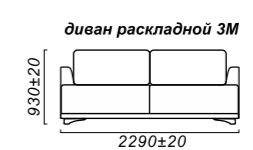
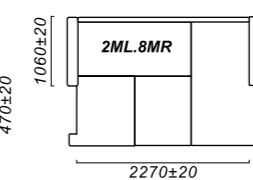

Механизм «Тик-так new»

Босфор 1, Босфор 1 М



560, 21 гр., 25ML.6MR



653, 19 гр., 25ML.6MR



655, 19 гр., 25ML.6MR



979, 19 гр., 25ML.6MR



30170, 20 гр., 25ML.6MR



151, 19 гр., 25ML.6MR



413, 20 гр., 25ML.6MR



30175, 20 гр., 25ML.6MR

Механизм: «Тик-так»

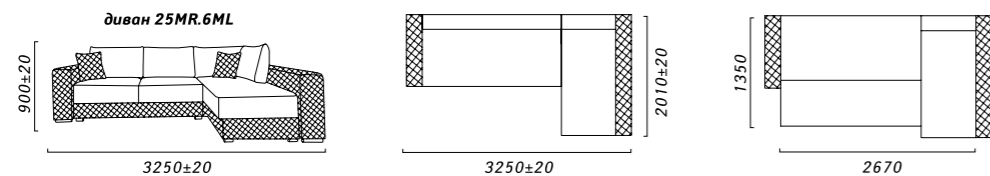

Бонсай 1



3(0), 19 гр., 3М



1, 19 гр., 3М



5, 19 гр., 3М



150, 19 гр., 3М



518, 20 гр., 3М



519, 20 гр., 3М



658, 19 гр., 3М



951, 19 гр., 3М

Механизм: «Тик-так»

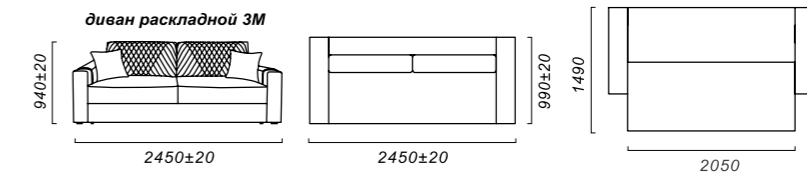

Брабус



3(0), 19 гр., 2ML904MR_



30128, 20 гр., 3М



5(0), 19 гр., 2ML904MR



30164, 20 гр., 3М



789, 20 гр., 2ML.90.4MR



212, 19 гр., 3М



358, 21 гр., 2ML904MR



429, 23 гр., 3М



948, 19 гр., 2ML904MR



558, 21 гр., 3М

Брабус



658, 19 гр., 2ML.90.4MR



8, 19 гр., 3М



149, 19 гр., 2ML904MR



782, 20 гр., 3М



988, 19 гр., 2ML.90.4MR



445, 20 гр., 3М



416, 20 гр., 2ML904MR



1006, 18 гр., 3М

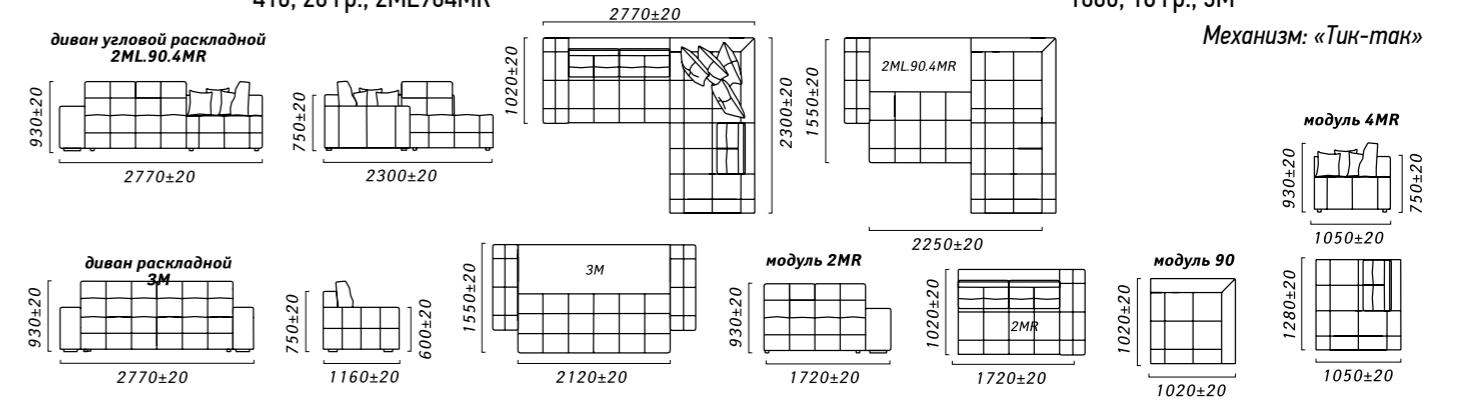



49+30345, 19 гр., 19gr_2ML.6MR



865+30043, 20 гр., 3MT



30289(0)+30289, 19 гр., 2ML.6MR



863+30025, 20 гр., 3MT



30292(0)+30292, 19 гр., 2ML.6MR



30289(0)+30289, 19 гр.,



444+1042, 20 гр., 2ML.6MR



31041+30028, 18 гр., 3MT



959+949, 19 гр., 2ML.6MR



30299+30263, 23 гр., 3MT



477+483, 19 гр., 2ML.6MR



1035+30217, 20 гр., 3MT



479+486, 19 гр., 2ML.6MR



1032+30041, 20 гр., 3MT



654+912(0), 19 гр., 2ML.6MR



31585(0)+30280, 19 гр., 3M



559+631, 21 гр., 2ML.6MR



8(0)+633, 19 гр., 3MT

Механизм «Тик-так»

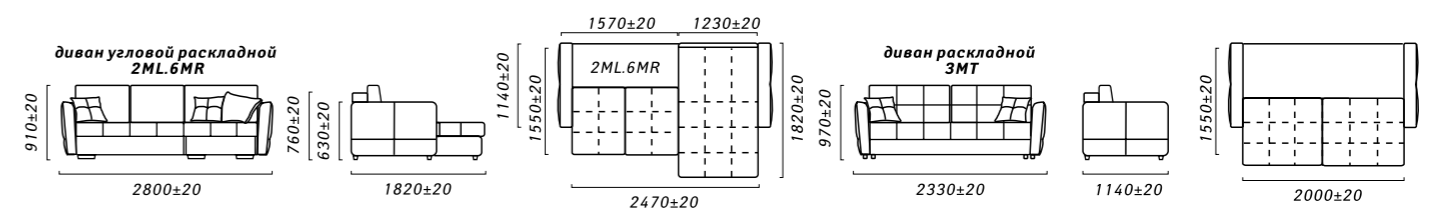



31589(0)+31581(0), 19 гр., 3М



860+30007, 20 гр., 3М



358+604, 21 гр., 3М



795_0+31596, 19 гр., 3М



30263+30281, 19 гр., 3М



30175+30171, 20 гр., 3М



513+910, 20 гр., 3М



521+30275, 20 гр., 3М



654+30015(0), 20 гр., 3М



654+30015(0), 20 гр., 12



1018+611, 18 гр.,



977+981, 19 гр., 3М



478+31596, 19 гр., 3М



445+813, 20 гр., 3М



913(0)+913, 21 гр., 3М



947+946, 19 гр., 3М



987+795(0), 19 гр., 3М



30170, 20 гр., 12

диван раскладной 3М

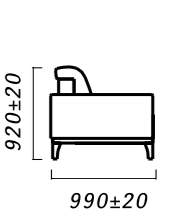
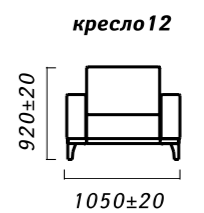
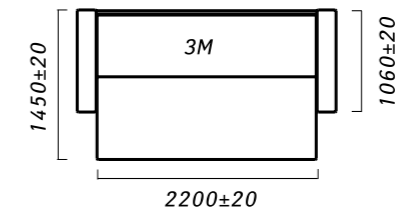
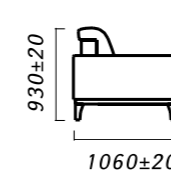
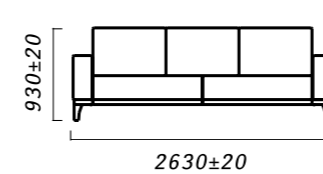

Механизм «Тик-так»

Роберто



444+446, 20 гр., 2ML.8MR



516+711, 20 гр., 2ML.8MR



657+908(0), 19 гр., 2ML.8MR_venge



558+30342, 21 гр., 2ML.8MR



681+631, 19 гр., 2ML.8MR



795(0)+1023, 19 гр., 2ML.8MR



812(0)+812, 24 гр., 2ML.8MR



1006+609, 19 гр., 2ML.8MR



979+912(0), 19 гр., 2ML.8R



977+611, 19 гр., 2ML.8MR

Роберто



1015+1015, 18 гр., 2ML.8MR



1017+712, 18 гр., 2ML.8MR



1018+31595, 18 гр., 2ML.8MR



31578(0)+710, 19 гр., 3ML.8MR



958+30263, 19 гр., 2ML.8MR



696+713, 21 гр., 2ML.8MR



30176+932, 20 гр., 2ML.8MR



30163+30162, 20 гр., 2ML.8MR

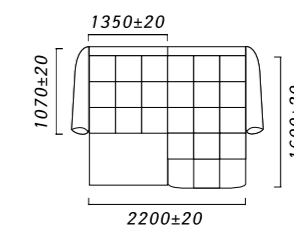
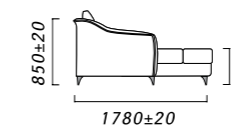

Механизм
«Дельфин»



1026(0)+908(0), 19 гр., 2L.6R



5+719, 19 гр., 2L.6R



982+915, 19 гр., 2ML.6MR



979+31594, 19 гр., 2L.6R



950+952, 19 гр., 2L.6R



948+912(0), 19 гр., 2ML.6MR



946+946, 19 гр., 2L.6R



681+631, 19 гр., 2ML.6MR



960+949, 19 гр., 2ML.6MR



250+249, 20 гр., 2ML.6MR



8+31594, 19 гр., 2ML.6MR



957+953, 19 гр., 2L.6R



955+915(0), 19 гр., 2ML.6MR



953+946, 19 гр., 2L.6R



952+30182, 20 гр., 2L.6R



947+946, 19 гр., 2ML.6MR



951+946, 19 гр., 2L.6R



413+412, 20 гр., 2ML.6MR

Короб для белья только у 2ML.6MR

Механизм: «Тик-так»

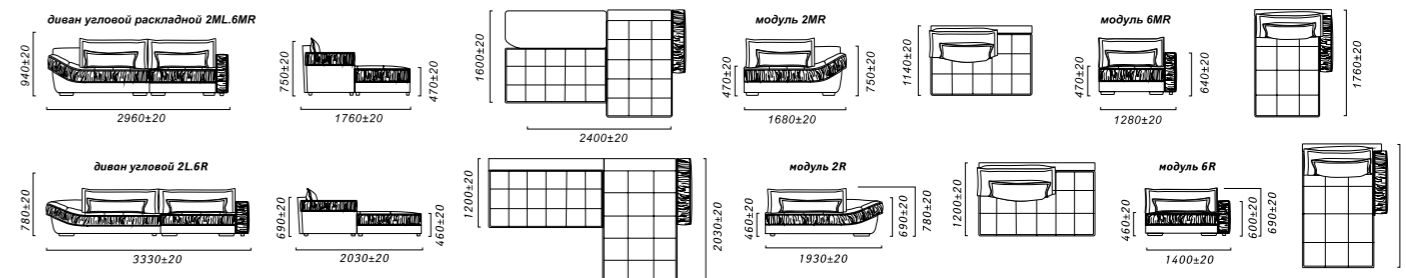



412+450, 20 гр., 3М



413+419, 20 гр., 3М



414+447, 20 гр., 3М



445+412, 20 гр., 3М



449+419, 20 гр., 3М



653+658, 19 гр., 3М



9(0)+6(0), 19 гр., 3М



149(0)+148, 19 гр., 3М



3(0)+30170, 19 гр., 3М



3+30170, 19 гр., 3М



657+655, 19 гр., 3М



659+652, 19 гр., 3М



653+658, 19 гр., 3М



985+984, 19 гр., 3М



1026(0)+1024, 19 гр., 3М



412+445, 20 гр., 3М



412+446, 20 гр., 3М



412+419, 20 гр., 3М

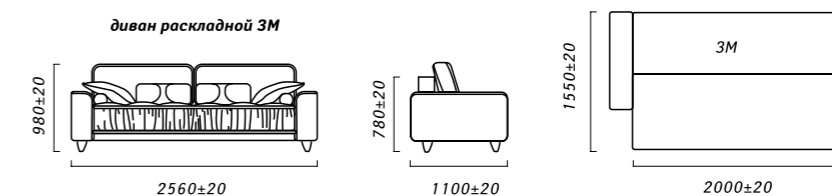

Механизм: «Тик-так»



447, 20 гр., 15L8R



519, 20 гр., 15L8R



521, 20 гр., 15L8R



652, 19 гр., 15L8R



654, 19 гр., 15L8R



657, 19 гр., 15L8R



658, 19 гр., 15L8R



659, 19 гр., 15L8R



977, 19 гр., 15L8R



979, 19 гр., 15L8R



952, 19 гр., 15L8R



955, 19 гр., 2ML.6R



982, 19 гр., 15L8R



7(0), 19 гр., 2ML.6R



989, 19 гр., 15L8R



30296, 23 гр., 2ML.6R



1006, 18 гр., 15L8R



31585(0), 19 гр., 2ML.6R

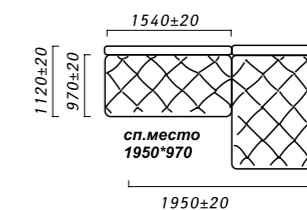
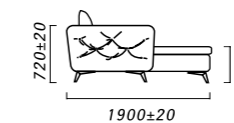
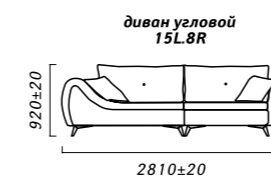

Дорса



1035, 20 гр., 3ML.8MR



727, 19 гр., 2ML.6MR



30130, 20 гр., 3ML.8MR



30133, 20 гр., 2ML.6MR



1037, 20 гр., 3ML.8MR



5, 19 гр., 2ML.6MR



31223, 19 гр., 3ML.8MR



486, 19 гр., 2ML.6MR



447, 20 гр., 3ML.8MR



250, 20 гр., 2ML.6MR

Дорса



30303, 23 гр., 3ML.8MR



31500, 19 гр., 2ML.6MR



30293(0), 19 гр., 3ML.8MR



31504, 19 гр., 2ML.6MR



656, 19 гр., 3ML.8MR



361, 21 гр., 2ML.6MR

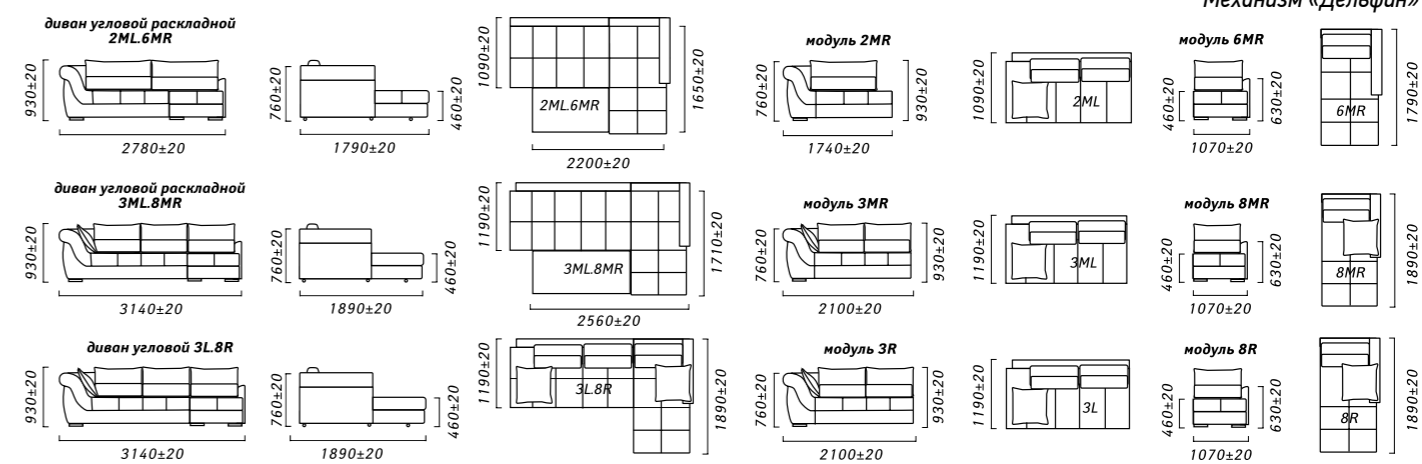

Вестерн



1032, 20 гр., 2ML20M8MR



7(0), 19 гр., 2ML.8MR



953, 19 гр., 2ML20M8MR



415, 20 гр., 2ML.8MR



412, 20 гр., 8ML20M924AR



30175, 20 гр., 2MR.8ML



419, 20 гр., 8ML20M5AR



361, 21 гр., 2ML.8MR



9(0), 19 гр., 8ML20M5AR



213, 19 гр., 2ML.8MR

Вестерн



150, 19 гр., 2ML914AR



553, 21 гр., 2ML5AR



521, 20 гр., 2ML5AR



435, 23 гр., 2ML5AR



359, 21 гр., 2ML924AR



30165, 20 гр., 2ML5AR

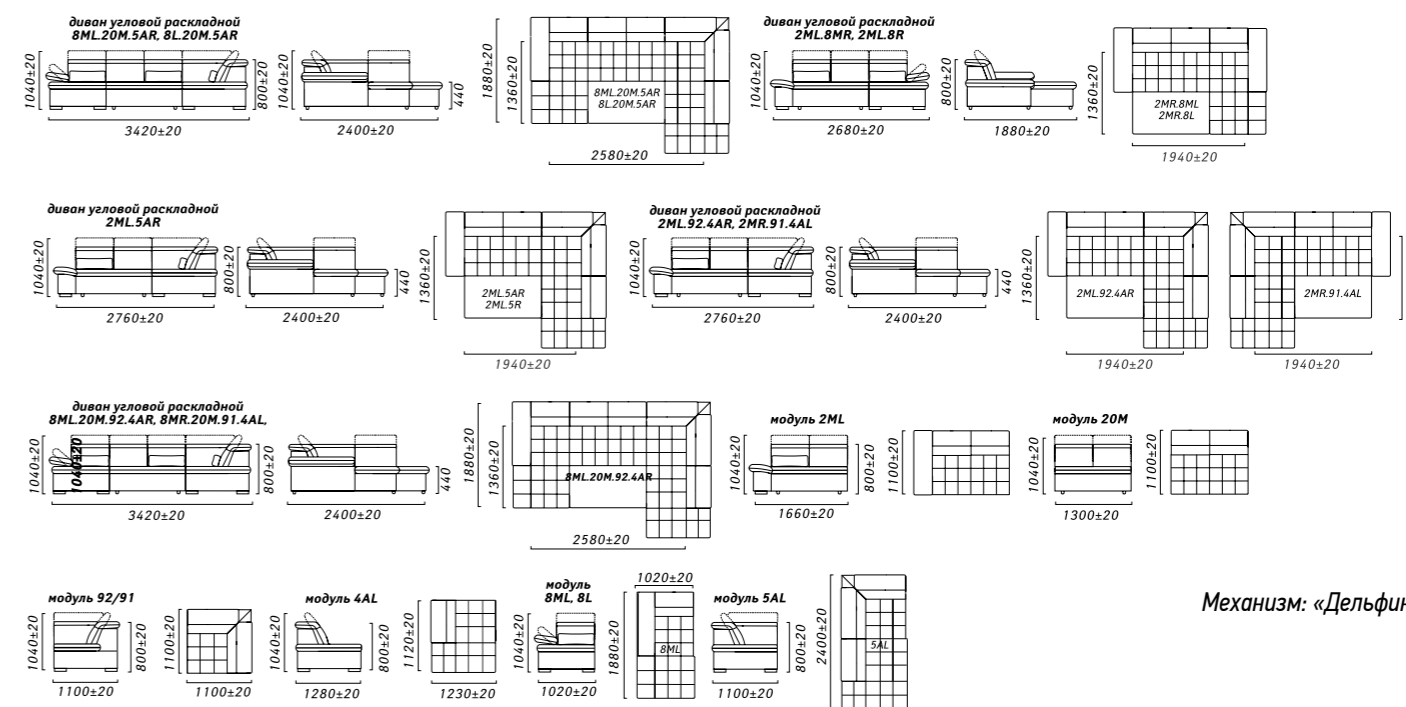

Механизм: «Дельфин»

Чери 1



Cheri_478(1)_472(1)+471(1)_472(1)_18gr._8ML.30M.90.1MR.jpg



472, 18 гр., 1ML.30M.1MR



31590(0)+31578(0)+31575(0), 19 гр., 8ML.30M.90.1MR



474, 18 гр., 1ML.30M.1MR

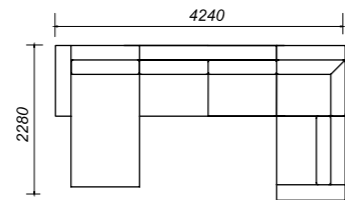
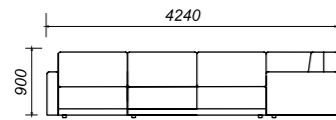

Механизм:
«Тик-так»

Блэк 1



31583(0)+151, 19 гр., 2ML.6MR



990+979, 19 гр., 2ML.6MR



31588(0)+150, 19 гр., 2ML.6MR



983+984, 19 гр., 2ML.6MR

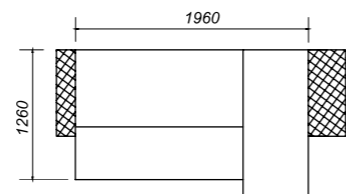
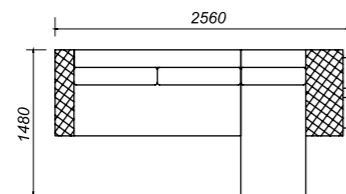
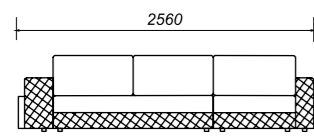

Механизм:
«Тик-так»

Ойра



19 гр., В-4, 477, 2ML.6R



19 гр., 31587(0), 6L.2M.6R



19 гр. + В-4, 482, 2ML.6R



19 гр., 31577, 6L.2M.6R



19 гр. + В-4, 482, 2ML.6R



19 гр., 31585, 6L.2M.6R

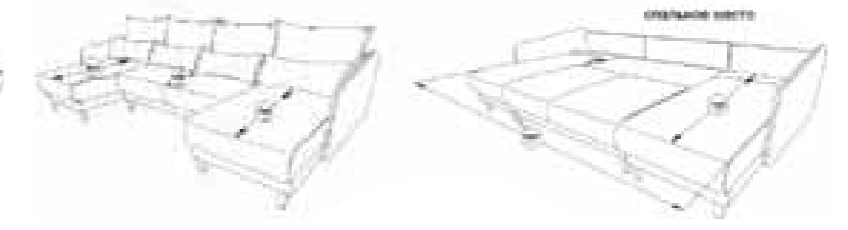
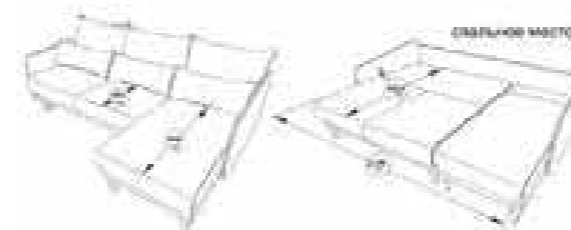

Ольса



30317, 22 гр., 2L.26R



1041+30057, 22 гр., 2L.2R



149(0), 19 гр., 2L.26R



999+Jaklin6, 19 гр.



150, 19 гр., 2R.206L



362, 21 гр., 2L.206R

"ОЛЬСА" 2L.2.6R

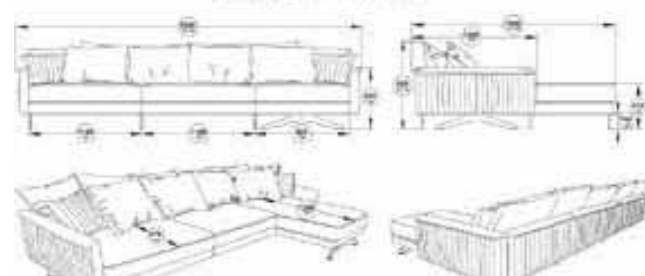

Гмах 3



655, 19 гр., 35



723, 19 гр., 35



727, 19 гр., 35



725, 19 гр., 35

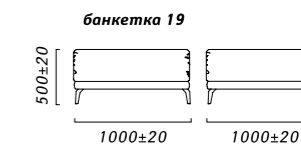
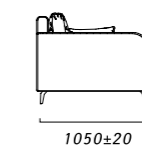
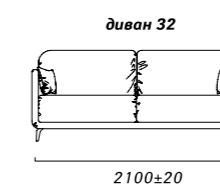
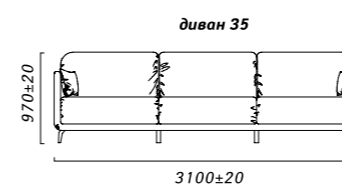

Тибо 1



30289(0)+30289(0), 19 гр., 1ML.30M.1MR



30290(0)+30290(0), 19 гр., 1ML.30M.1MR



30292(0)+30292(0), 19 гр., 1ML.30M.1MR



30290(0)+30290, 19 гр., 3ML.90.1MR

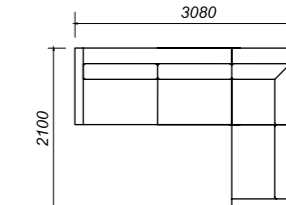
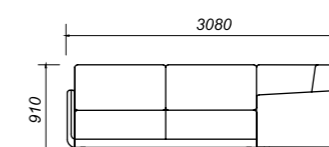

Механизм:
«Тик-так»

Стефано 1



48, 19 гр., 2ML.6R



49, 19 гр., 2ML.6R



31583(0), 19 гр., 2ML.6R



979, 19 гр., 2ML.6R



545, 18 гр., 2ML.6R



513, 20 гр., 2ML.6R



483, 19 гр., 2ML.6R



477, 19 гр., 2ML.6R



44, 19 гр., 2ML.6R



46, 19 гр., 2ML.6R

Стефано 1



45, 19 гр., 3M



44, 19 гр., 3M

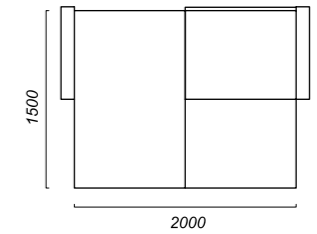
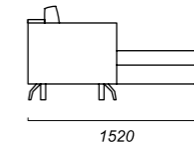
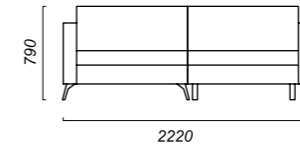

Механизм:
«Тик-так»

Паркер 1



1021, 19 гр., 2L.6R



980, 19 гр., 2L.6R



981, 19 гр., 2L.6R



990, 19 гр., 2L.6R

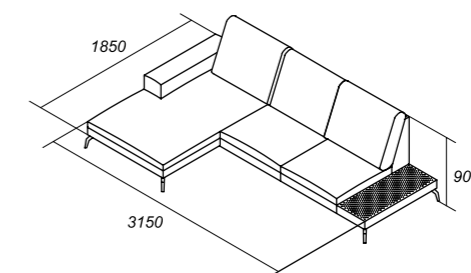

Спирит



380, 19 гр., 3ML.6R



381, 19 гр., 3ML.6R



382, 19 гр., 3ML.6R



384, 19 гр., 3ML.6R



385, 19 гр., 3ML.6R



386, 19 гр., 3ML.6R



388, 19 гр., 3ML.6R



389, 19 гр., 3ML.6R

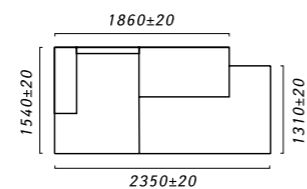
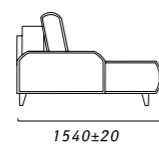
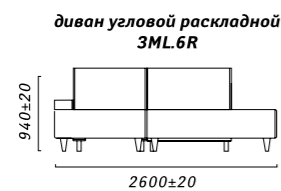

Роджер



44, 19 гр., 2ML.6R



46, 19 гр., 2ML.6R



461, 21 гр., 2ML.6R



462, 21 гр., 2ML.6R



463, 21 гр., 2ML.6R



48, 19 гр., 2ML.6R



49, 19 гр., 2ML.6R

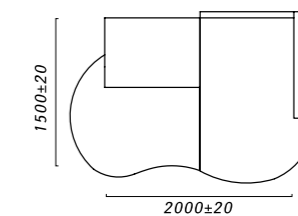
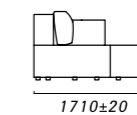

Механизм: «Тик-так»

Лонди



1, 19 гр., 2L.5R



48, 19 гр., 2L.5R



150, 19 гр., 2L.5R



30308, 22 гр., 2L.5R



31225, 19 гр., 2L.5R



44, 19 гр., 2L.5R

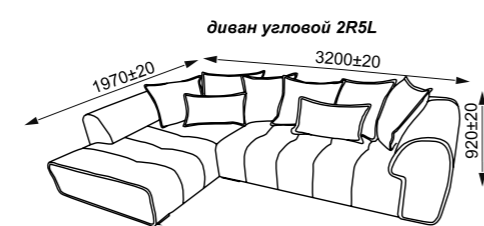
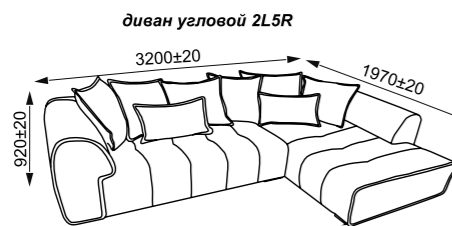

Эрика 1



380, 19 гр., 20ML.6R



381, 19 гр., 20ML.6R



382, 19 гр., 20ML.6R



384, 19 гр., 20ML.6R



385, 19 гр., 20ML.6R



386, 19 гр., 20ML.6R



388, 19 гр., 20ML.6R



389, 19 гр., 20ML.6R

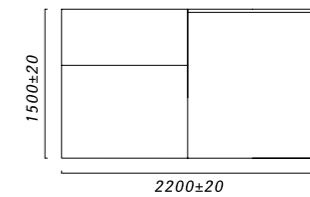
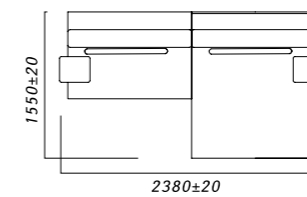
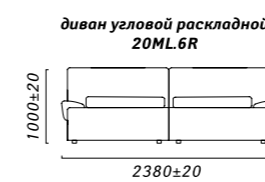

Механизм: «Тик-так»

Дакар 2



30141+30025, 20 гр., 2ML.8MR



30135+908(0), 20 гр., 25M



31043+30042, 19 гр., 2ML.8MR



951+951, 19 гр., 25M



30175+908, 20 гр., 2ML.8MR



31503+30029, 29 гр., 25M



30177+949, 20 гр., 2ML.8MR



31041+30025, 18 гр., 3M



1026(0)+1026(0), 19 гр., 2ML.8MR



654, 19 гр., 12

Дакар 2



30140+919, 20 гр., 2ML.8MR



30170+31597, 20 гр., 25M



30143+30141, 20 гр., 2ML.8MR



31045+597, 18 гр., 25M



30163+606, 20 гр., 3M



565+30346, 21 гр., 25M



3(0)+3(0), 19 гр., 3M



30175+908, 20 гр., 3M

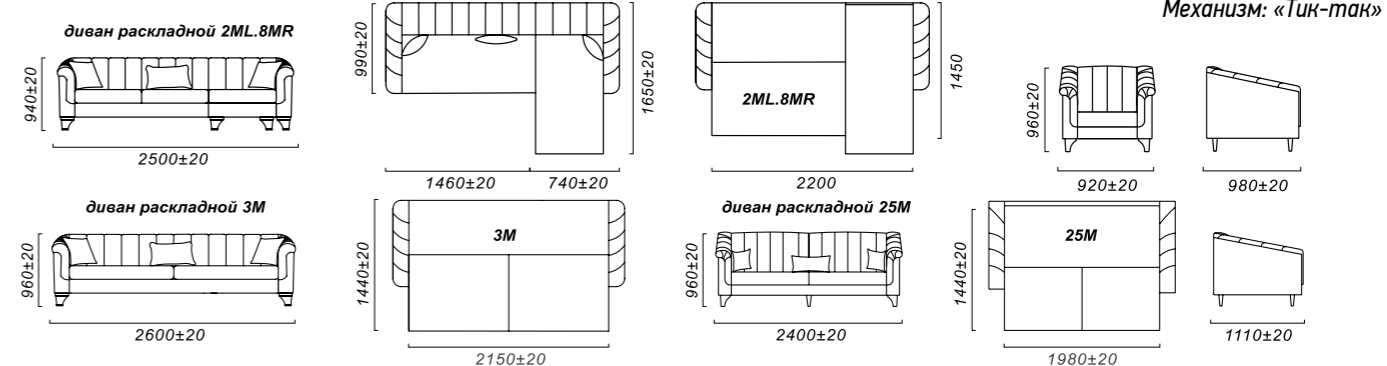

Монро 1



250+8+151, 20 гр., 2ML.8MR



361+364+364, 21 гр., 3M



520+520+520, 20 гр., 2ML.8MR



514+513+515, 20 гр., 3M



655+657+658, 19 гр., 2ML.8MR



955+955+955, 19 гр., 3M



30170+30176, 19 гр., 3M



417, 20 гр., 3M



558+1029+1020, 21 гр., 3M



990+990+990, 19 гр., 3M

Монро 1



984+30164+30170, 19 гр., 3M



987+987+987, 19 гр., 3M



30170+30176, 19 гр., 3M



31582(0), 19 гр., 3M

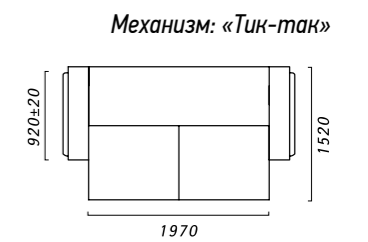
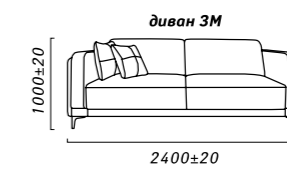
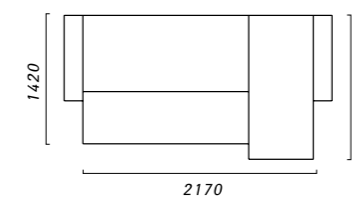
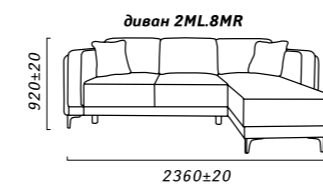

Мэри 1



30295, 23 гр., 2MR.8ML



31585(0), 19 гр., 2ML.8MR



516, 20 гр., 2ML.8MR



518, 20 гр., 2ML.8MR

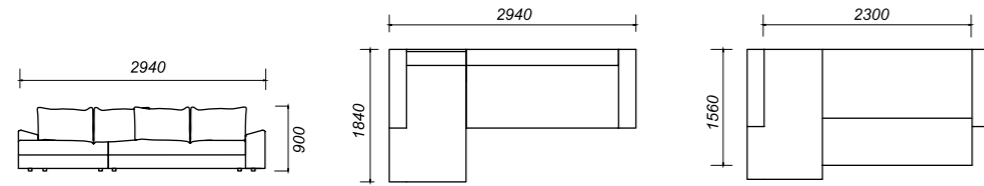

Шарон



20гр., 449, 2ML6R



19гр., 656, 3M



20гр., 521, 3M



23гр., 662, 3M

Механизм: «Пантограф»

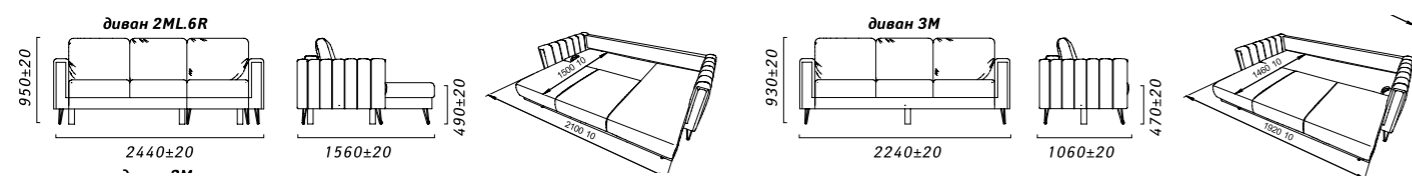

Корк



246, 20 гр., 2ML.6R



558, 21 гр., 2ML.6R



989, 19 гр., 2ML6R



31503, 19 гр., 2ML.6R



659, 19 гр., 2ML.6R



696, 21 гр., 2ML.6R



30134, 20 гр., 2ML.6R



31510, 19 гр., 2ML.6R

Съемные боковины в секции 2ML

Механизм: «Тик-так»

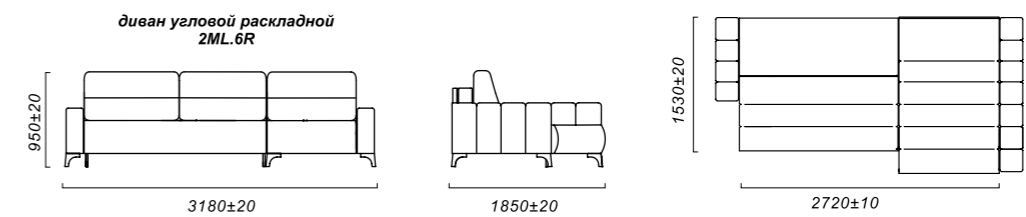



723, 19 гр., 2ML.8MR



724, 19 гр., 2ML.8MR



728, 19 гр., 2ML.8MR



1001, 19 гр., 2ML.8MR



148(0), 19 гр., 2ML.8MR



149(0), 19 гр., 2ML.8MR



947, 19 гр., 2ML.8MR



952, 19 гр., 2ML.8MR



950, 19 гр., 2ML.8MR



951, 19 гр., 2ML.8MR



414, 20 гр., 2ML.8MR



31581(0), 19 гр., 2ML.8MR



1030(0), 19 гр., 2ML.8MR



1026(0), 19 гр., 2ML.8MR



1017, 18 гр., 2ML.8MR



1012, 18 гр., 2ML.8MR



984, 19 гр., 2ML.8MR



1013, 18 гр., 2ML.8MR

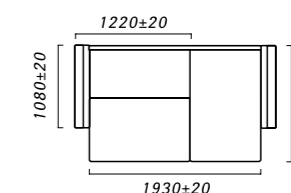
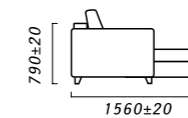
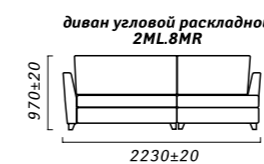

Механизм: «Тик-так»



723, 19 гр., 2ML.8MR



725, 19 гр., 2ML.8MR



727, 19 гр., 2ML.8MR



1033, 20 гр., 2ML.8MR



1041, 20 гр., 2ML.8MR



31577(0), 19 гр., 2ML.8MR



988, 19 гр., 2ML.8MR



551, 21 гр., 2ML.8MR



518, 20 гр., 2ML.8MR



364, 21 гр., 2ML.8MR



31504, 19 гр., 2ML.8MR



520, 20 гр., 3M



30127, 20 гр., 2ML.8MR



30163, 20 гр., 3M



8, 19 гр., 2ML.8ML



412, 20 гр., 2ML.8MR



149, 19 гр., 2ML.8MR



483, 19 гр., 2ML.8MR

диван угловой раскладной
2ML.8MR

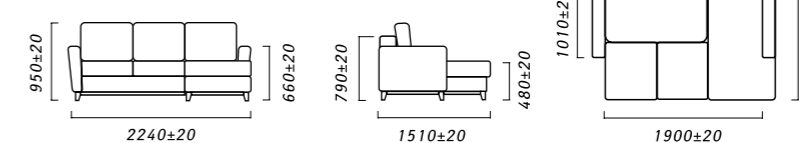

Механизм: «Тик-так»

Бариста



31503, 19 гр., 2ML.8MR



31507, 19 гр., 3M



31037, 19 гр., 2ML.8MR



747, 20 гр., 3M



6(0), 19 гр., 2ML.8MR



723, 19 гр., 3M



653, 19 гр., 2ML.8MR



658, 19 гр., 3M



31591(0), 19 гр., 2ML.8MR



989, 19 гр., 3M

Бариста



31590(0), 19 гр., 2ML.8MR



1042, 20 гр., 3M



31578(0), 19 гр., 2ML.8MR



31039, 18 гр., 3M



1025, 19 гр., 2ML.8MR



5, 19 гр., 3M



30293(0), 19 гр., 2ML.8MR



1030(0), 19 гр., 3M

Механизм «Тик-так»

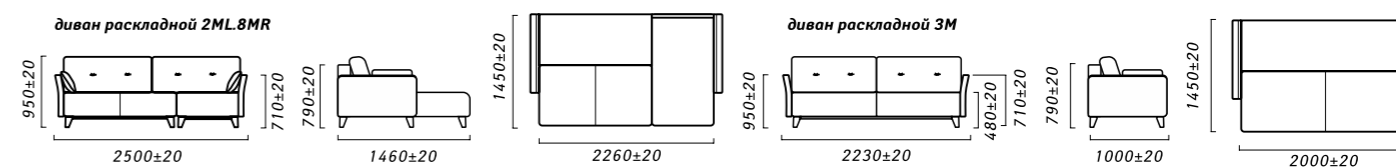

Осорно



30134, 20 гр., 3М



308+302, 19 гр., 3М



517+513, 20 гр., 3М



658+655, 19 гр., 3М



946+957, 19 гр., 3М



957+946_ гр., 3М



989+979, 19 гр., 3М

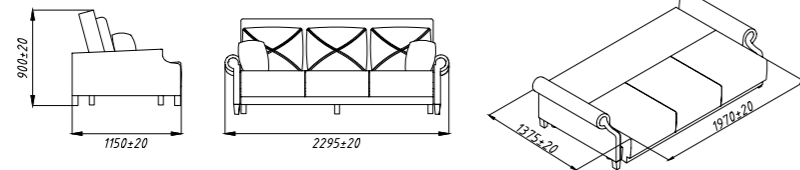

Механизм: «Книжка»

Завея



20 гр, 30175, 3М



20 гр., 30164, бук



20 гр, 30170, 3М



20 гр., 30177, бук



19 гр, 30168, 3М



20 гр., 30165, бук

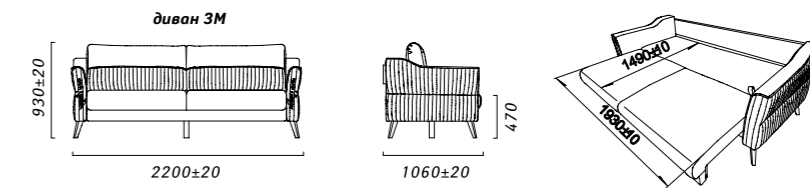

Механизм: «Пантограф»

Пэрис 1



514, 20 гр., 3М



951, 19 гр., 3М



1016, 18 гр., 3м



30165, 20 гр., 3М



30173_20g_3М



30175, 20 гр., 3М



30176_20g_3М



30177_20g_3М



444, 20 гр., 3М



656, 19 гр., 3М

Пэрис 1



979, 19 гр., 3М



1005, 18 гр., 3М

Механизм: «Тик-так»

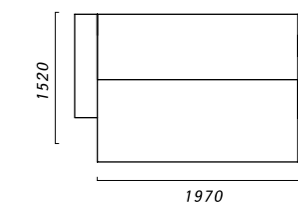
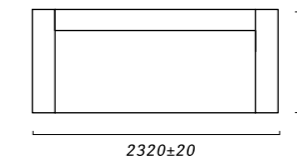
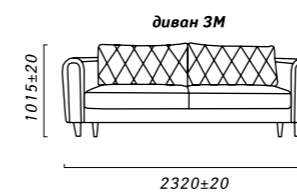

Кант



30145+30138, 20 гр., 3М



30138+30145, 20 гр., 2МL.6R



419+413, 19 гр., 2МL.6R



30138+30145, 20 гр., 2МL.6R

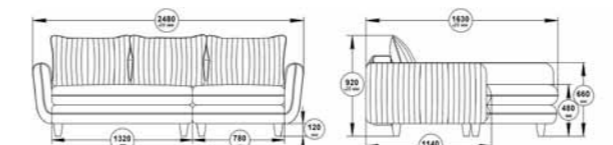

спальное место

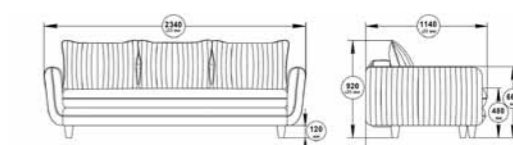
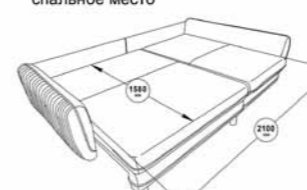

спальное место

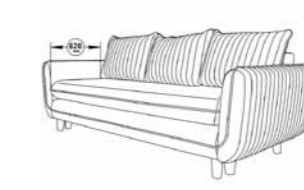

Барни 1



44+44, 19 гр., 2ML.8MR



30291(0)+30291, 19 гр., 3M



652+652, 19 гр., 2ML.8MR



478+486, 19 гр., 3M



1016+912, 18 гр., 3M



658+31596, 19 гр., 3M



985+985, 19 гр., 3M



1006+31594, 18 гр., 3M

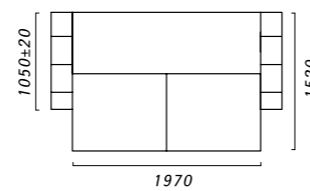
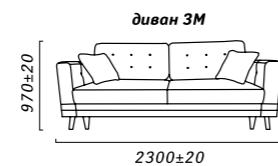
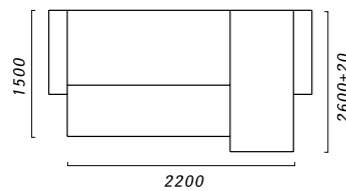
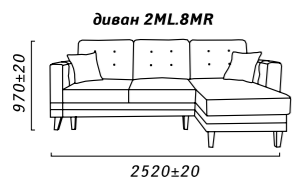

Механизм: «Тик-так»

Юта 1



6(0), 19 гр., 3M



415, 20 гр., 3M



655, 19 гр., 3M



987, 19 гр., 3M



988, 19 гр., 3M



990, 19 гр., 3M



30175, 20 гр., 3M

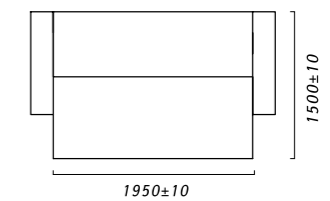
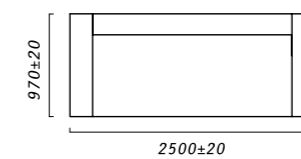
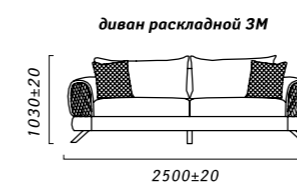

Механизм: «Тик-так»

Осирис



30177+30177, 20 гр., 2ML.6MR



479+8(0), 19 гр., 3M



1006+31594, 18 гр., 2ML.6MR



481+710, 19 гр., 3M



302+306, 19 гр., 2ML.6MR



1013+1016, 18 гр.,



977+980, 19 гр.,



977+980, 19 гр., 12

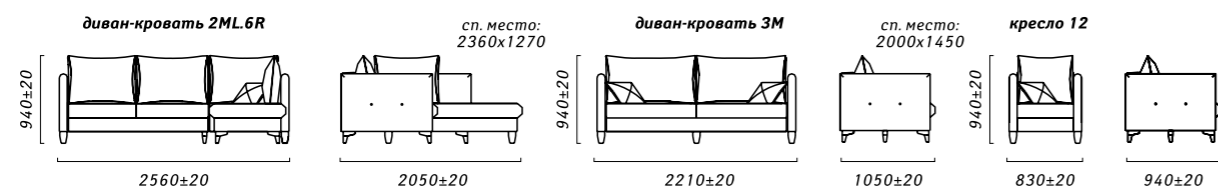

Золак 2



18гр, 1016+31596, 3M



18гр., 1005+232_3M



21гр, 556+556, 3M



19гр, 657+657, 3M



18гр., 486+632, 3M

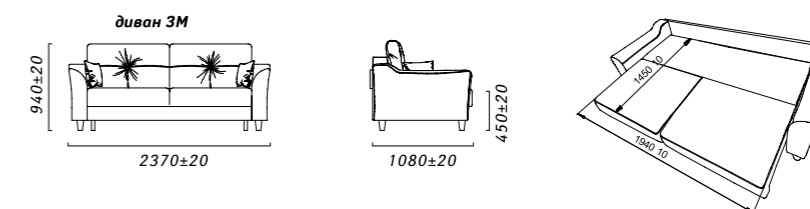

Один



3(0), 19 гр., 2ML.6R



8, 19 гр., 2ML.6R



988_19 гр_2ML.6R



1006, 18 гр., 2ML6R



1005, 18 гр., 2ML6R



1016, 18 гр., 2ML6R



551, 21 гр., 2ML.6R



415, 20 гр., 2ML.6R

Габаритные размеры, мм.:
L - 2330±20
B - 1560 ±20
H - 930 ±20

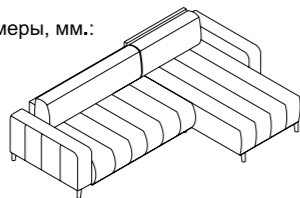

Спальное место, мм:
L - 2020
B - 1520

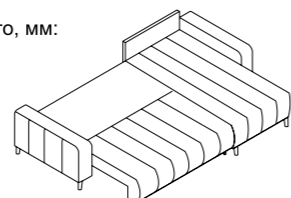

Механизм: «Тик-так»

Аргус 1



196(0), 19 гр., 2ML.6R



196, 19 гр., 2ML.6R



197(0), 19 гр., 2ML.6R



197, 19 гр., 2ML.6R



199(0), 19 гр., 2ML.6R



296, 19 гр., 2ML.6R

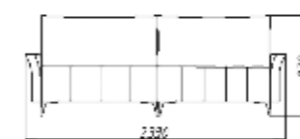

Латте 1



477, 19 гр., 2ML.8MR



46, 19 гр., 3M



479, 19 гр., 2ML.8MR



8, 19 гр., 3M



483, 19 гр., 2ML.8MR



148, 19 гр., 3M



486, 19 гр., 2ML.8MR



150, 19 гр., 3M



1005, 18 гр., 2ML.8MR



199, 19 гр., 3M

Латте 1



1006, 18 гр., 2ML.8MR



1020, 19 гр., 3M



361, 21 гр., 3M



366, 21 гр., 3M



521, 20 гр., 3M



198, 19 гр., 3M

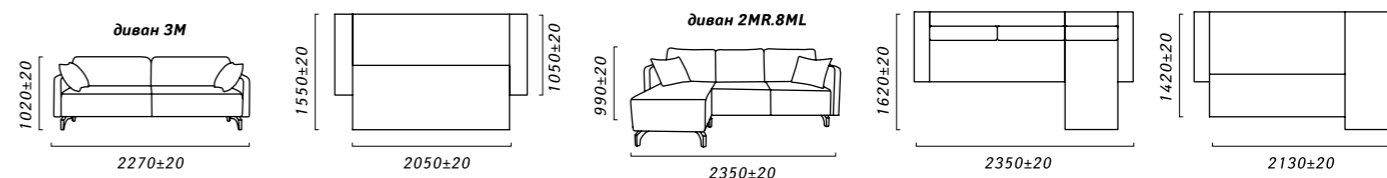

Механизм: «Тик-так»

Инфинити Люкс



9(0), 19 гр., 3ML.8MR



716, 19 гр., 3M



565, 21 гр., 3ML.8MR



1001, 19 гр., 3M



31581(0), 19 гр., 3ML.8MR



31037, 19 гр., 3M



1030(0), 19 гр., 3ML.8MR



416, 20 гр., 3M



246, 20 гр., 3ML.8MR



431, 23 гр., 3M

Инфинити Люкс



30135, 20 гр., 2ML.6MR



884, 20 гр., 3M



30284, 22 гр., 2ML.6MR



887, 20 гр., 3M



31578(0), 19 гр., 2ML.6MR



499, 22 гр., 12

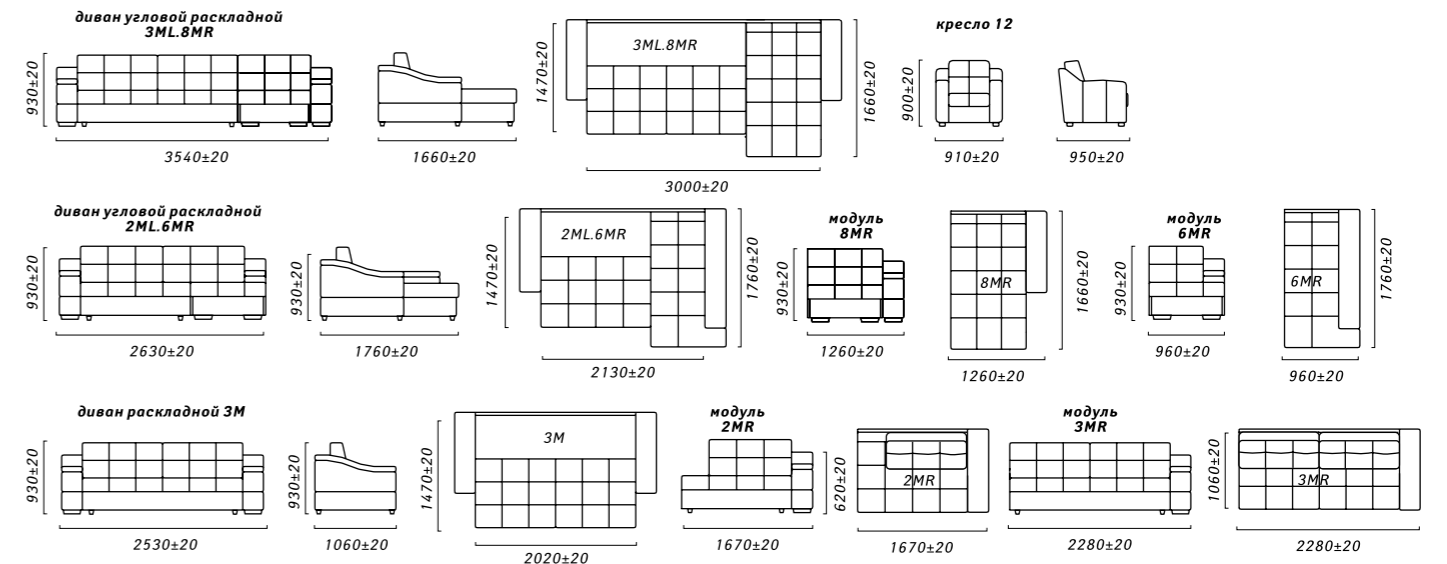

Баттерфляй



30316+30218, 22 гр., 2ML.6R



30102+30051, 19 гр., 3M



30346+30170, 23 гр., 2ML.6R



1034+30043, 20 гр., 3M



251+912, 20 гр., 2ML.6R



1041+30029, 20 гр., 3M



30317+30219, 22 гр., 2ML.6R



30314+30294, 22 гр., 3M



486+31594, 19 гр., 2ML.6R



484+712, 19 гр., 3M

Баттерфляй



30316+30218, 22 гр., 2ML.6R



884+30057, 20 гр., 3M



797(0)+30281, 19 гр., 2ML.6R



887+30057, 20 гр., 3M



30341+30174, 23 гр., 2ML.6R



30131+30057, 20 гр., 3M



520+364, 20 гр., 3M



979+913(0), 19 гр., 3M

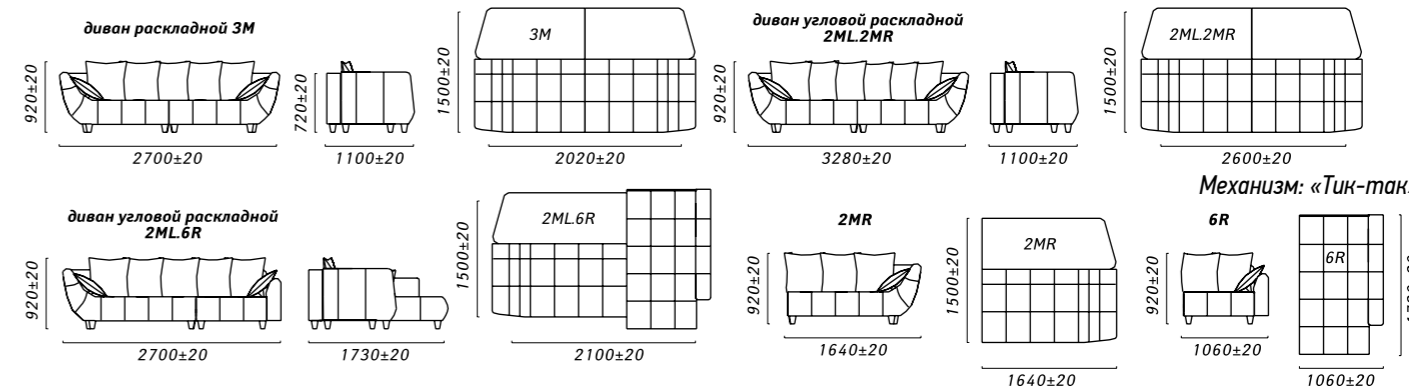

Матео Люкс



31583(0), 19 гр., 2ML.6MR



889, 20 гр., 3M



30129, 20 гр., 2ML.6MR



30128, 20 гр., 3M



990, 19 гр., 2ML.6MR



30130, 20 гр., 3M



414, 20 гр., 2ML.6MR



30134, 20 гр., 3M



6(0), 19 гр., 2ML.6MR



444, 20 гр., 3M

Матео Люкс



148, 19 гр., 2ML.6MR



992, 19 гр., 3M



413, 20 гр., 2ML.6MR



1002, 19 гр., 3M



513, 20 гр., 2ML.6MR



210, 19 гр., 3M



552, 21 гр., 2ML.6MR



652, 19 гр., 3M_p

диван угловой раскладной 2ML.6MR

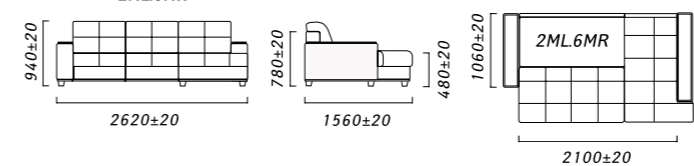

диван раскладной 3M

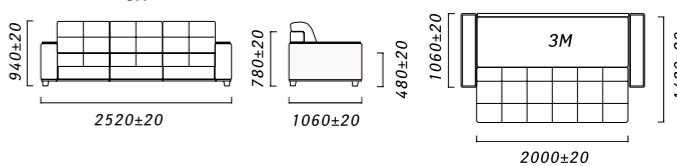

Механизм: «Тик-так»

Матисс Люкс



153+550, 19 гр., 1R9020M1L



994+994, 19 гр., 2ML..6MR



983+211, 19 гр., 1L20M6MR



482+482, 19 гр., 2ML.6MR

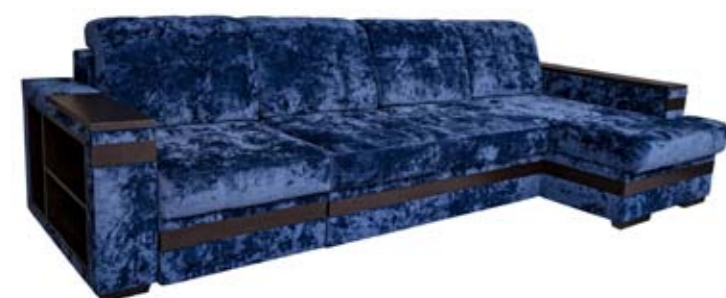

959+959, 19 гр., 6MR20M1L



659+435, 19 гр., 2ML.6MR



661+661, 23 гр., 1L20M6MR



499+499, 22 гр., 2ML.6MR



412+418, 20 гр., 1L20M901R



149(0)+148(0), 19 гр., 2ML.6MR

Матисс Люкс



31581(0)+213, 19 гр., 1R.90.20M6ML



151+151, 19 гр., 2ML.6MR



148(0)+148(0), 19 гр., 6ML20M901R



1025+493, 19 гр., 2ML.6MR



30261+435, 19 гр., 6ML20M6MR



653+554, 19 гр., 2ML.6MR

Цвет пленки декоративных элементов: венге, сосна рандерс

Механизм: «Тик-так»

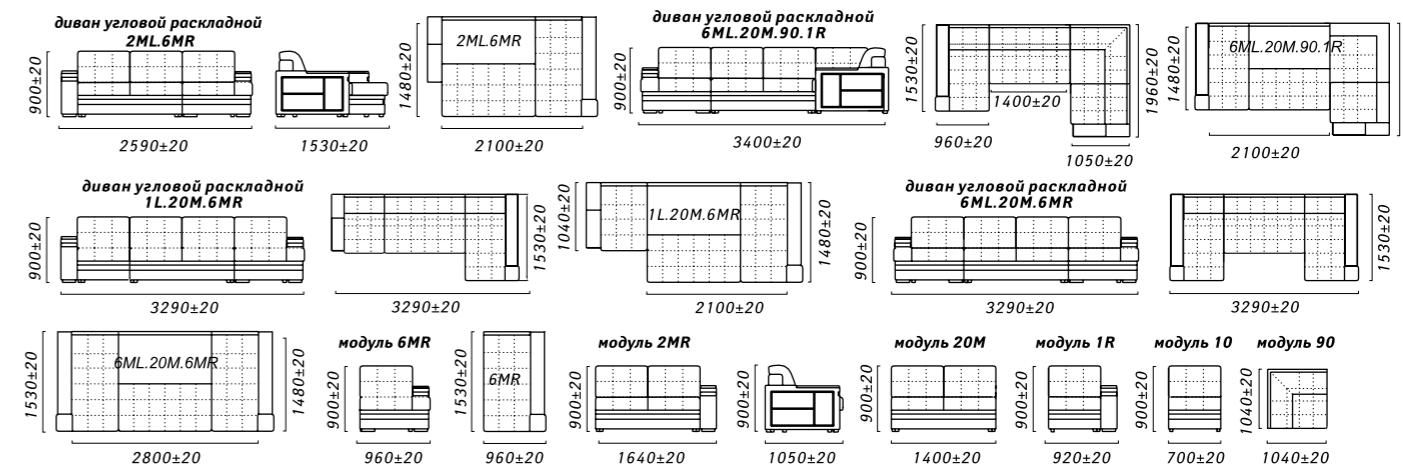

Рейн 1



652+910(0), 19 гр., 3ML.5MR



698+711, 21 гр., 3ML.5MR



953+953, 19 гр., 3ML.5MR



1017+30179, 19 гр., 3ML.5MR

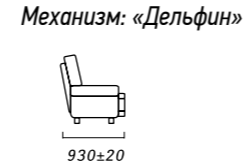
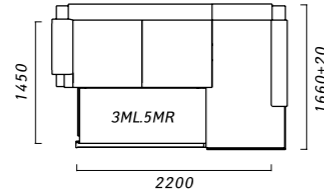
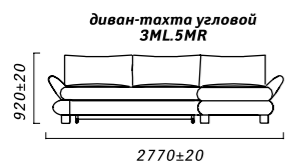

Механизм: «Дельфин»

Вагнер



1006, 18 гр., 3ML.6MR



987, 19 гр., 3M



984, 19 гр., 3ML.6MR



657, 19 гр., 12

Механизм: «Тик-так»

Диван-кровать 3M

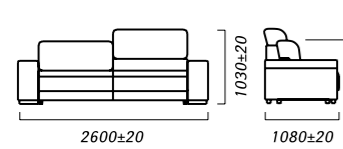

Диван-кровать угловой 3ML6MR

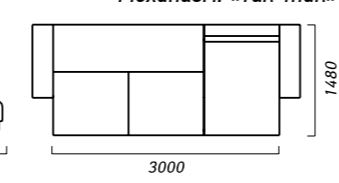
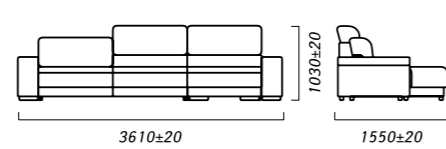

Кресло 12

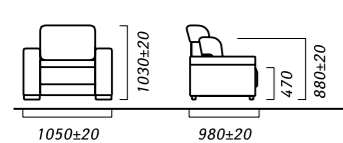

3ML/R

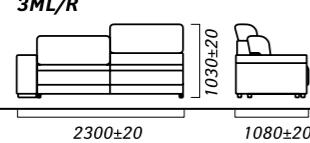

162

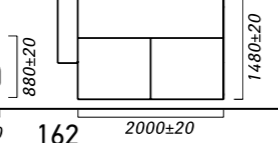

6ML/R

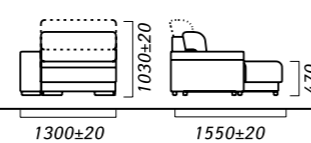

Кларк 1



1038, 20 гр., 2ML.6R



471, 18 гр., 2ML.6R



513, 20 гр., 2ML.6R



997, 19 гр., 2ML.6R



520, 20 гр., 2ML.6R



9(0), 19 гр., 2ML.6R



545, 18 гр., 2ML.6R

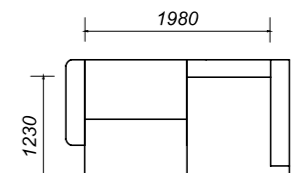
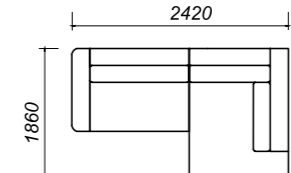
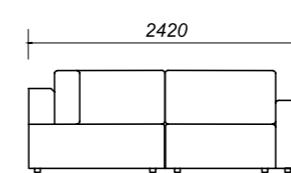

Веймар Плюс



1016+1016+912, 18 гр., 3ML.6MR



149+149+31594, 19 гр., 3ML.1MR



8+551+31216, 20 гр., 3ML.6MR



519+519+523, 20 гр., 3MR.1ML



148+148+710, 19 гр., 3ML.6MR



1022+1022+910(0), 19 гр., 3ML.1MR



360+360+360, 21 гр., 3ML.6MR



364+364+364, 21 гр., 3MR.1ML



652+654+652, 19 гр., 3ML.6MR



654+654+654, 19 гр., 3ML.1MR

Веймар Плюс



30293(0)+30293(0)+30293, 19 гр., 3ML.6MR



1017+1017+712, 18 гр., 3ML.6MR



980+980+990, 19 гр., 3ML.6MR



1015+1015+710, 18 гр., 3ML.6MR



703+703+712, 21 гр., 3ML.6MR

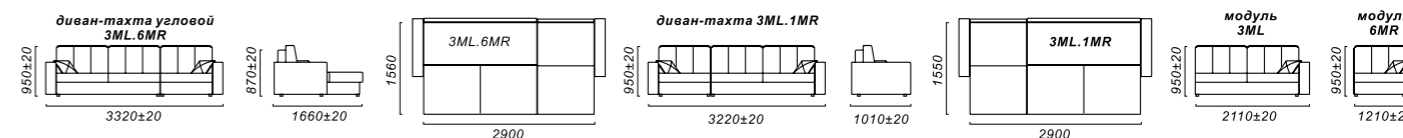

Механизм: «Еврокнижка»

Аксель 1



30128, 20 гр., 2ML.8MR



30133, 20 гр., 2ML.8MR



30134, 20 гр., 2ML.8MR



31035, 19 гр., 2ML.8MR



485, 19 гр., 2ML.8MR



30295, 23 гр., 2ML.8MR



44, 19 гр., 2ML.8MR



49, 19 гр., 2ML.8MR



50, 19 гр., 2ML.8MR



48, 19 гр., 2ML.8MR

Аксель 1



861, 20 гр., 2ML.8MR



477, 19 гр., 2ML.8MR



149(0), 19 гр., 2ML.8MR



795(0), 19 гр., 2ML.8MR

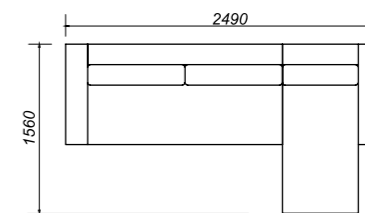
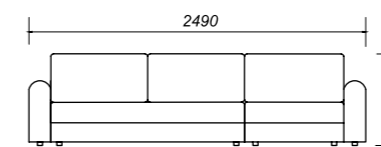

Механизм:
«Тик-так»

Рэм 1



3(0), 19 гр., 2ML.8MR



770, 19 гр., 2ML.8MR



774, 19 гр., 2ML.8MR



766, 19 гр., 2ML.8MR

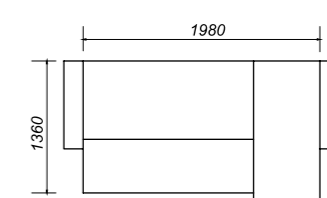
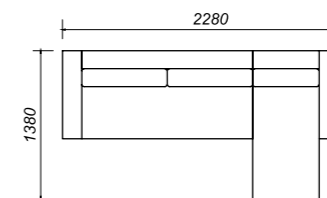
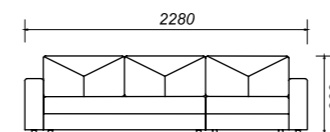

Механизм:
«Тик-так»

Бони 1



450+419+447, 20 гр., 3М



655+655+711, 19 гр., 3М



479+1016+31596, 19 гр.,



987+980+609, 20 гр., 3М



1005+1016+31596, 18 гр., 3М



1011+1006+31594, 18 гр.,



1013+1006+31594, 18 гр., 3М



1019+1016+31595, 18 гр., 3М

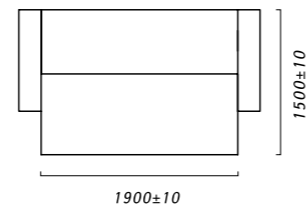
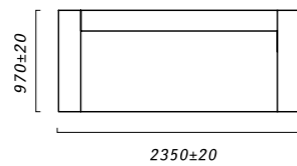
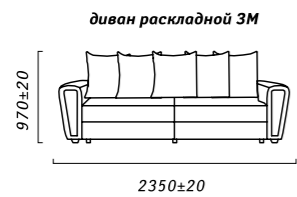

Механизм: «Тик-так»

Ален 1



482+30177, 19 гр., 3М



486+30160, 19 гр., 3М



Ален_478+30162, 19 гр., 3М



479+480, 19 гр., 3М



483+30162, 19 гр., 3М



545+546, 18 гр., 3М



717+720, 19 гр., 3М



716+715, 19 гр., 3М

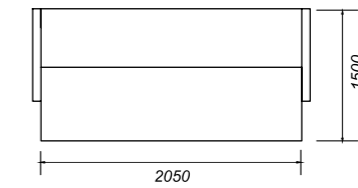
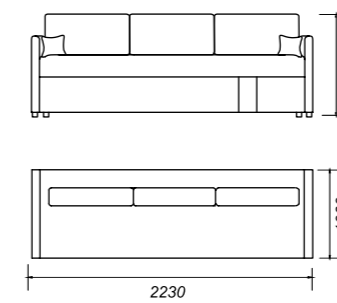

Люси 1 Плюс



460, 21 гр., 3М



461, 21 гр., 3М



462, 21 гр., 3М



463, 21 гр., 3М

Люси Плюс



Люси Плюс, 460, 21 гр., 3М



Люси Плюс, 461, 21 гр., 3М



Люси Плюс, 462, 21 гр., 3М



Люси Плюс, 463, 21 гр., 3М



Ронни 1



502+502, 22 гр., 3М



980+557, 19 гр., 3М



983+983, 19 гр., 3М



989+209, 19 гр., 3М



984+985, 19 гр., 3М



31045+211, 18 гр., 3М



31502+31501, 19 гр., 3М



31503+215, 19 гр., 3М

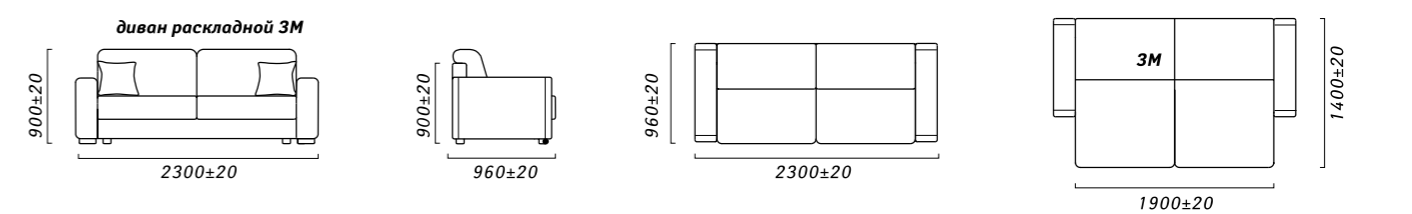

Мелисса



9(0)+9(0), 19 гр., 2ML.6MR



989+989, 19 гр., 2ML.6MR



444+444, 20 гр., 2ML.6MR



3(0)+3, 19 гр., 3M



652+654, 19 гр., 2ML.6MR



7(0)+435, 19 гр., 2ML.6MR



981+983, 19 гр., 2ML.6MR



1020+214, 19 гр., 3M



984+986, 19 гр., 2ML.6MR



251+249, 20 гр., 12

Мелисса



989+989, 19 гр., 2ML.6MR



979+990, 19 гр., 3M



1017+214, 18 гр., 2ML.6MR



31587+31583, 20 гр., 12

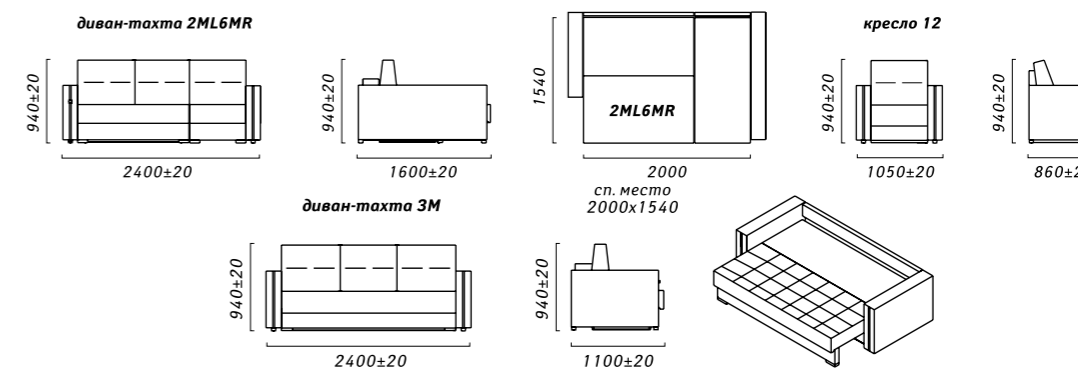

Механизм:
«Еврокнижка»

БЭК-2



31592(0), 19 гр., 3М



30293, 19 гр., 3М



800(0), 19 гр., венге, 3М



30290(0), 19 гр., 3М



795(0), 19 гр., венге, 3М



30284, 22 гр., 3М



30287, 22 гр., 3М



655, 19 гр., 12



654, 19 гр., 12

Механизм: «Книжка»

диван-кровать 3М

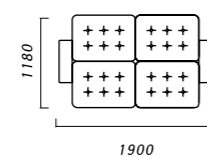
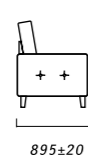
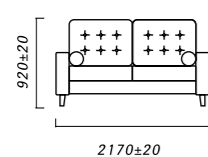

кресло 12

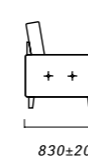
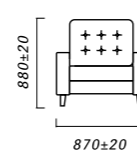

Канон 1



951, 19 гр., 3М



477, 19 гр., 3М



947, 19 гр., 3М



31582(0), 19 гр., 3М



556+556, 21 гр. + В-2, 12



45+45, 19 гр. + В-4, 12



46+46, 19 гр. + В-4, 12



Royal_910+910(0), 21 гр., 22

Механизм: «Книжка»

диван-тахта 3М

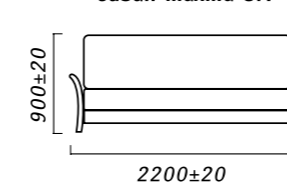

диван 22



кресло 12

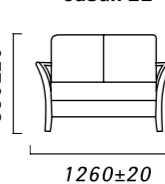

кресло 12

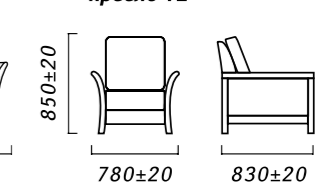

Бергамо



1019+1016, 18 гр., 3М



1018+1017, 18 гр., 3М



977+981, 19 гр., 3М



1014+31200, 18 гр., 3М

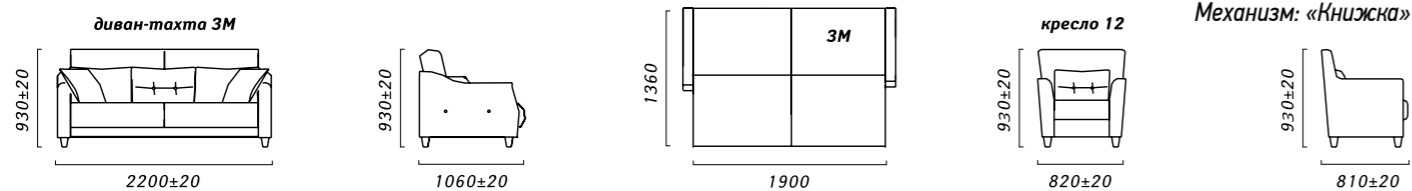

Аква



988_19 гр_3М



985, 19 гр., 3М



30160, 20 гр., 3М



989, 19 гр., 3М

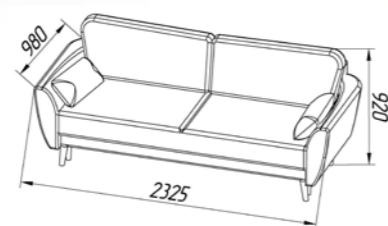

Механизм: «Тик-так»

Азалия



412+413+412, 20 гр., 3М



485+214+711, 19 гр., 3М



1012+216+710, 18 гр., 3М



1017+214+31594, 18 гр., 3М



1017+499+30179, 19 гр., 3М

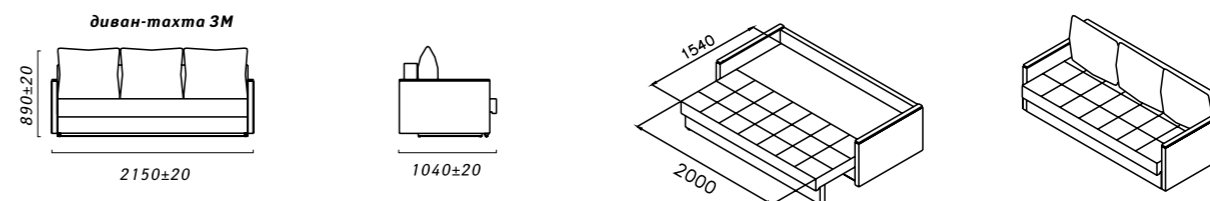

Механизм: «Еврокнижка»

Томсон 1



483+211, 19 гр., 3М



652+652, 19 гр., 3М



654+437, 19 гр., 3М



977+977, 19 гр., 3М



658+654, 19 гр., 3М



148+149, 19 гр., 3М



210+216, 19 гр., 3М



477+477, 19 гр., 3М

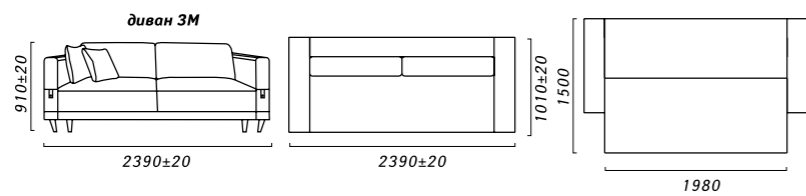

Механизм: «Тик-так»

Фарго 1



3(0)+5(0), 19 гр., 3М



212+209, 19 гр., 3М



983+981, 19 гр., 3М



1015+1011, 18 гр., 3М



1017+1016, 18 гр., 3М



1018+1019, 18 гр., 3М



30165+30166, 20 гр., 3М

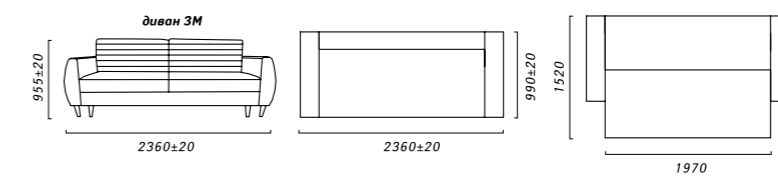

Механизм: «Тик-так»

Аер

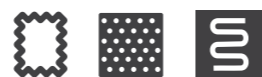

148(0), 19 гр.



149, 19 гр.



150, 19 гр.



514, 20 гр.



519, 20 гр.



523, 20 гр.

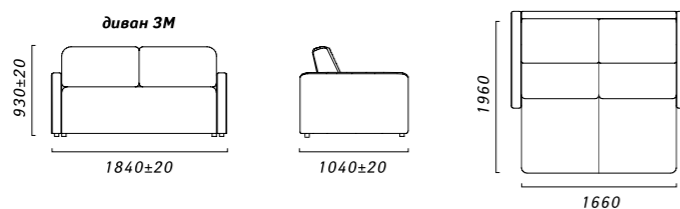

Механизм: «Пума»

Нео 1



946, 19 гр., 3М



956, 19 гр., 3М



980, 19 гр., 3М



987, 19 гр., 3М



989, 19 гр., 3М



958, 19 гр., 3М

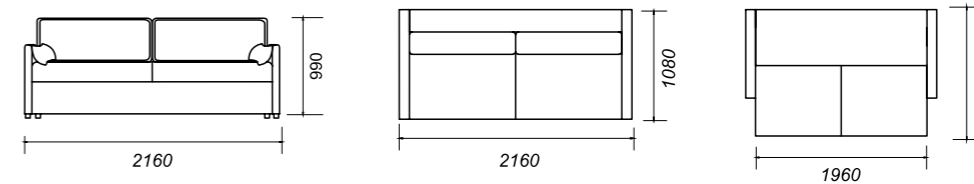

Механизм: «Тик-так»

Амазонка 1



717, 19 гр., 3М



9(0), 19 гр., 3М



7(0), 19 гр., 3М



151, 19 гр., 3М



153, 19 гр.



956, 19 гр., 3М



987, 19 гр., 3М



1027, 19 гр., 3М

Механизм: «Тик-так»

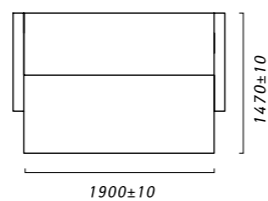
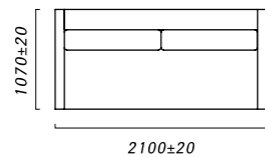
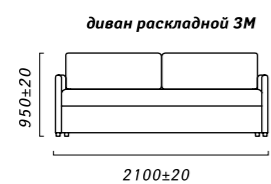

Шелби Плюс



1005, 18 гр., 3М



1006, 18 гр., 3М



1015, 18 гр., 3М



1017, 18 гр., 3М



1018, 18 гр., 3М

Механизм: «Книжка»

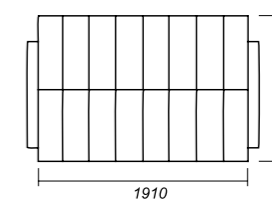
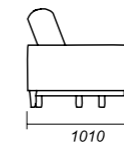
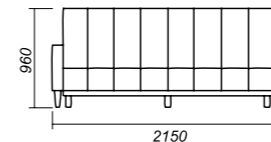

Лейла 1



1005, 18 гр., 3М



1006, 18 гр., 3М



951, 19 гр., 3М



1017, 18 гр., 3М



1018, 18 гр., 3М

Денди 1



1029, 19 гр., 3М



149(0), 19 гр., 3М



149, 19 гр., 3М



150, 19 гр., 3М



31512, 19 гр., 3М



984, 19 гр., 3М



988, 19 гр., 3М



148, 19 гр., 3М

Механизм: «Еврокнижка»

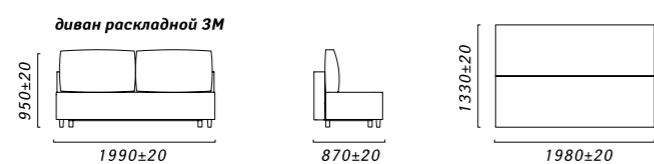

Механизм: «Еврокнижка»

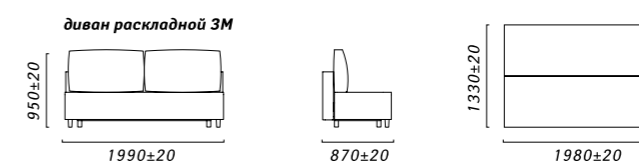

Молина



654, 19 гр., 3М



415, 19 гр., 3М



7(0), 19 гр., 3М



1018, 18 гр., 3М



983, 19 гр., 3М

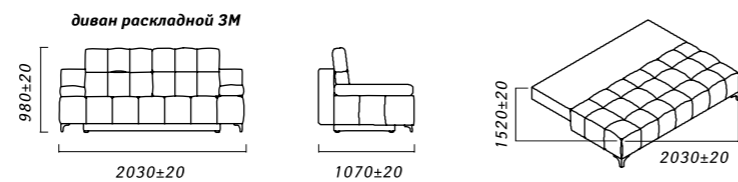

Мариша



31500+30051, 19 гр., 3М



31501+30009, 20 гр., 3М

Мариша



30293(0)+30293, 19 гр., 3М



30288(0)+30288, 19 гр., 3М



30292(0)+30292, 19 гр., 3М



1016+912, 18 гр., 3М



31504+30008, 20 гр., 3М



31509+30042, 19 гр., 3М



986+911(0), 19 гр., 3М



31508+30007, 20 гр., 3М

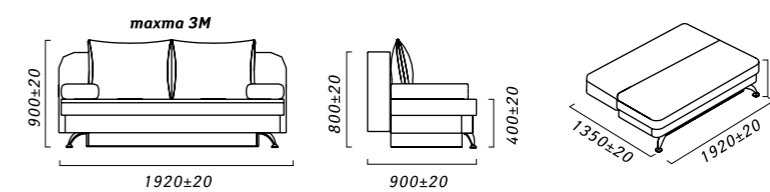

Лаваль



1018, 18 гр., 3М



1017, 18 гр., 3М



1005, 18 гр., 3М



979, 19 гр., 3М



1004, 18 гр., 3М



1006, 18 гр., 3М

Орегон 1



1030, 19 гр., 25М



30168, 21 гр., 3М



1026, 19 гр., 25А



556, 21 гр., 3М



30166, 20 гр., 1М



983, 19 гр., 25М



984, 19 гр., 25М

Механизм: «Еврокнижка»

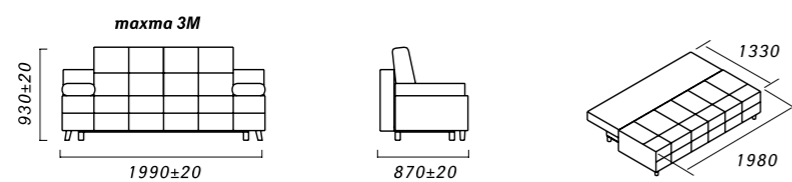

Механизм: «Аккордеон»

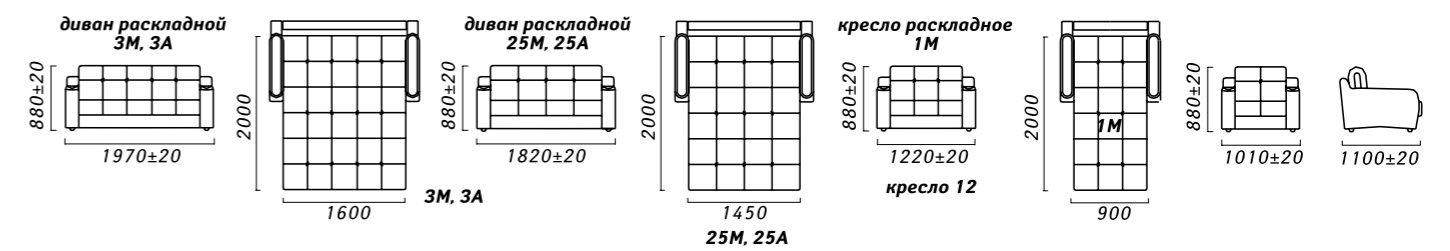

Локи 1



1017, 18 гр., 2М



1019, 18 гр., 2М



148, 19 гр., 2М



149, 19 гр., 2М



3(0), 19 гр., 2М



31582(0), 19 гр., 2М



31583(0), 19 гр., 2М



546, 18 гр., 2М



717, 19 гр., 2М

Механизм: «Вперед раскладной»

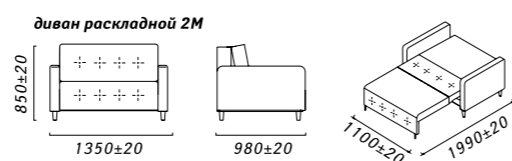

Ариэль



977+914, 19 гр., 0R



1027, 19 гр., 0R



148, 19 гр., 0R



1026, 19 гр., 0R



1023, 19 гр., 0R



984+608, 20 гр., 0R



363, 21 гр., 0R



953, 19 гр., 0R

Механизм: «Еврокнижка»

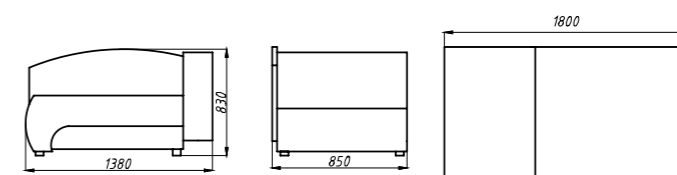

Икар



19 гр., 199(0), 3М



20 гр., 30170, 3М



19 гр., 196(0), 3М



19 гр., 198, 3М

Механизм: «Клик-кляк» с подъемными подлокотниками

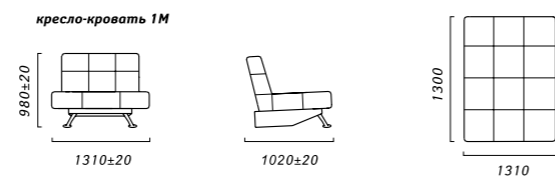
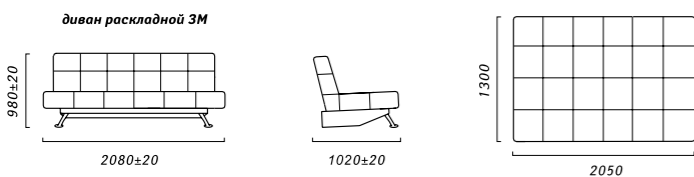

Клёк

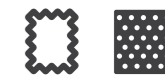

19 гр., 795(0), 1М



19 гр., 5, 25М



19 гр., 31587(0)+31583(0), 25М



19 гр., 30288(0)+30288, 1М



19 гр., 800(0), 1М

Механизм: «Анкордеон»

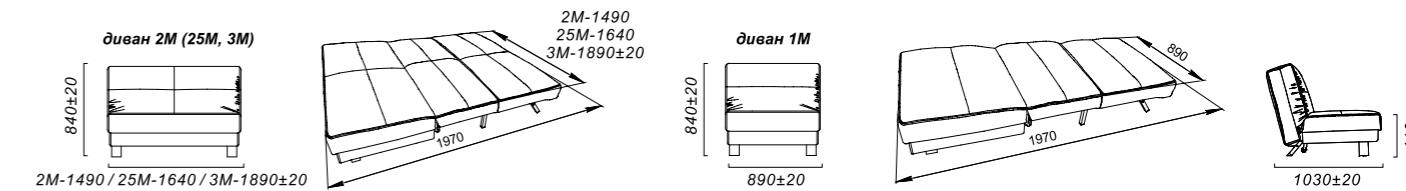

Никки



19 гр., 659, 3М



19 гр., 657, 3М

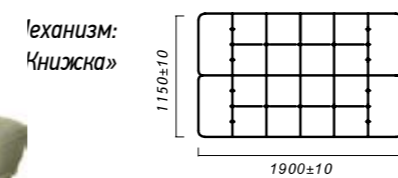

21 гр., 462, 3М



21 гр., 463, 3М

Нова



19 гр., 658+656, 3М



19 гр., 959+959, 3М

Механизм: «Тик-так»



19 гр., 48+45, 3М



19 гр., 652+653, 3М

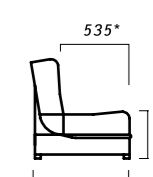
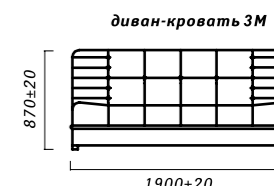

Эльф 1



656, 19 гр., 2М



654, 19 гр., 2М



1018, 18 гр., 2М



658, 19 гр., 2М



556+557, 21 гр., 2М



211, 19 гр., 2А



987+987(0), 20 гр., 2М

Модуль 2А оснащен коробом для белья

диван раскладной 2М, 2А

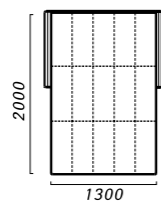
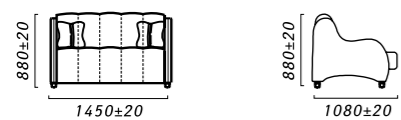

кресло-кровать 1М

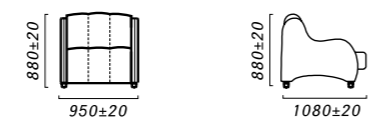

Механизм: «Анкордеон»

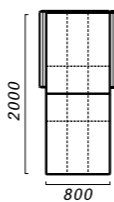

Бриз 1



977, 19 гр., 2М



514, 20 гр., 2М



1016, 18 гр., 2М



1015, 18 гр., 2М



1005, 18 гр., 2М



1006, 18 гр., 2М



795(0), 19 гр., 2М



988, 19 гр., 1М

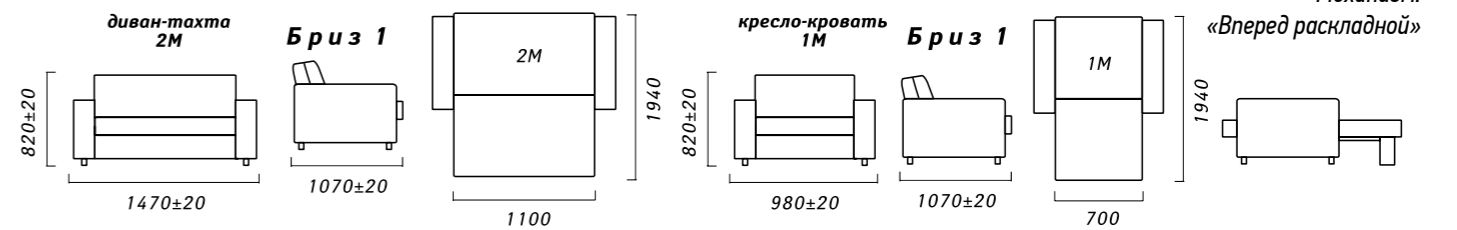

Платон 1



978, 19 гр., 22



1004, 18 гр., 22



30168, 20 гр., 22



30170, 20 гр., 22

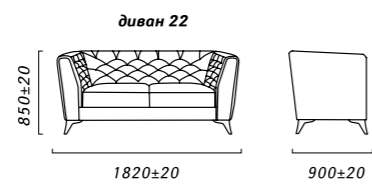

Симон 1



30176, 20 гр., 22



499, 22 гр., 22



30174, 20 гр., 22



358, 21 гр., 22



30175, 19 гр., 22



959, 19 гр., 22



19 гр., 988, 22



1017, 18 гр., 22



30163, 20 гр., 22

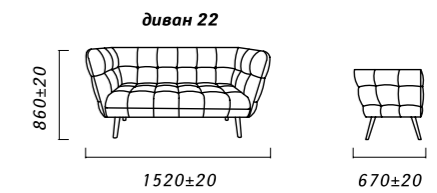

Марсел 1



565, 21 гр., 22



551, 21 гр., 12



30161, 20 гр., 12



424, 23 гр., 22



556, 21 гр., 12



208, 19 гр., 12

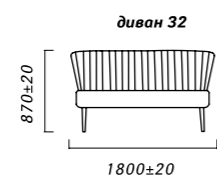
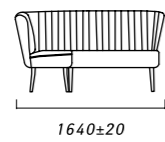
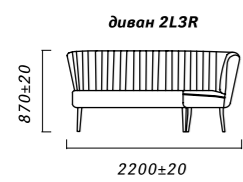

Лорд 1



981, 19 гр., 32



249, 20 гр., 22



30168, 20 гр., 32



498, 22 гр., 22



30174, 20 гр., 32



558, 21 гр., 22



556, 21 гр., 22



481, 19 гр., 22



30165, 20 гр., 12

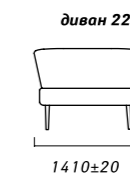
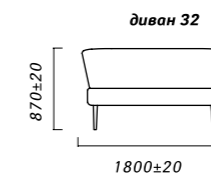

Джой



1012, 18 гр., 0L



1015, 18 гр., 0L



31037, 19 гр., 0L



34985, 23 гр., 0L

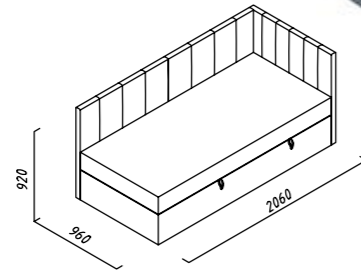

Подъемный механизм

Дана 1



150+150, 19 гр., 90LT



149, 19 гр., 90LT



951+951, 19 гр., 90LT



45+45, 19 гр., 90LT

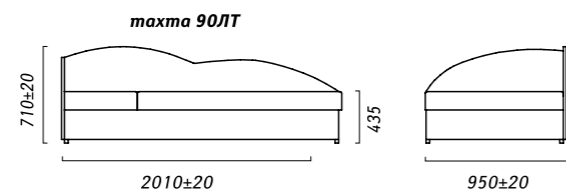

Подъемный механизм

Палац



19 гр., 212, венге



19 гр., 30163, венге



19 гр., 959, венге



22 гр., 493



20 гр., 30174, венге



20 гр., 30168, венге



22 гр., 30315

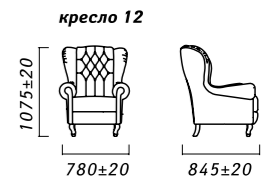

Ларс



519, 20 гр., 12



770 Essence, 19 гр.



767 Essence, 19 гр.



771 Essence, 19 гр.



775 Essence, 19 гр.



17, 3(0), 19 гр.



17, 149, 19 гр.



18, 6(0), 19 гр.

Кая

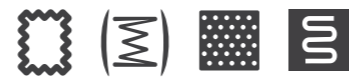

22 гр, 205, 12, слон кость (В-2)



20 гр, 30165, 12



гр. 19, 958, 12, слон кость (В-2)



гр. 19, 958, 18



20 гр, 517, 12



23 гр, 672, 12

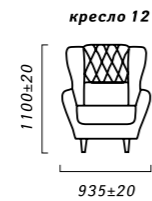

кресло 12



кресло 12



банкетка 18



банкетка 18

Кая 1



19 гр., 959, 12



19 гр., 951, 12



19 гр., 955, 12



22 гр, 206, 12, венге



19 гр, 957, 18, венге



20 гр, 30176, 12

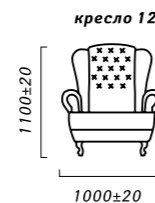

кресло 12



кресло 12



банкетка 18



банкетка 18

Оскар 11



19 гр., 148, 12



20 гр., 30174, 12



19 гр., 657, 12



19 гр., 659, 12



23 гр., 428, 12



20 гр., 30164, 12



21 гр., 556, 12



19 гр., 49, 12



21 гр., 461, 12



21 гр., 462, 12



21 гр., 462, 18



23 гр., 431, 12

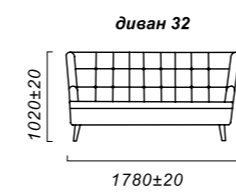

диван 32

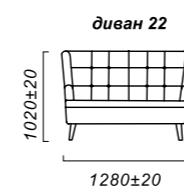

диван 22

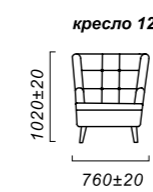

кресло 12



кресло 12



банкетка 18



банкетка 18

Орио 1



9(0), 19 гр..jpg



6(0), 19 гр..jpg



5, 19 гр..jpg



8, 19 гр..jpg

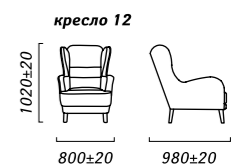

кресло 12

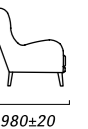

кресло 12

Ли́ра 1



19 гр., 655,12



19 гр., 658, 12



19 гр., 948, 12



31042, 18 гр., 12



20 гр., 30174, 12



21 гр., 565, 12

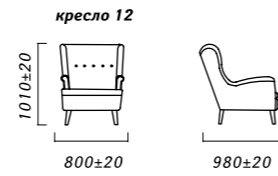

Бонда



208, 19 гр., 12



149(0), 19 гр., 12



30175, 20 гр., 12



151(0), 19 гр., 12

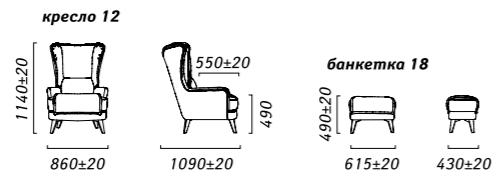

Крок



18 гр, 944+945, 12



19 гр, 81+81, 12



19 гр, 83+83, 12



18 гр, 262+30263, 12

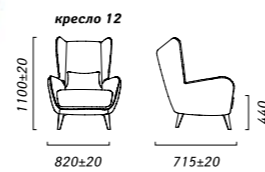

Ча́ра



3(0), 19 гр., 12



8(0), 19 гр., 12



518, 20 гр., 12



518, 20 гр., 18



17(0), 19 гр., 12



9(0), 19 гр., 12

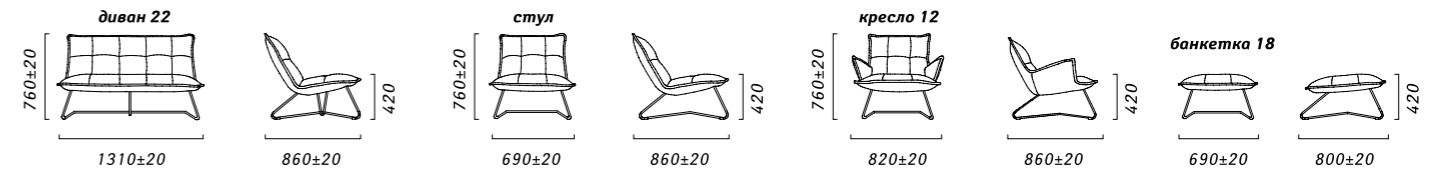

Лясе́



19 гр., 9(0)+1, 12A



19 гр., 149+153, 12A



412+412, 20 гр., 22S

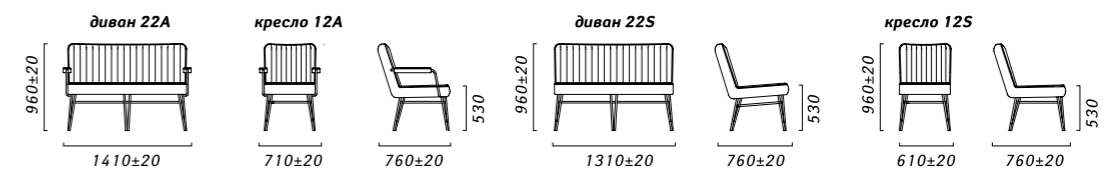

Камила



462, 21 гр., 12

521, 20 гр., 12

30176, 20 гр., 12

516, 20 гр., 12



988, 19 гр., 12

38975(0), 23 гр., 12

1005, 18 гр., 12

1019, 18 гр., 12



1004, 18 гр., 12

1011, 18 гр., 12

523, 20 гр., 12

557, 21 гр., 12

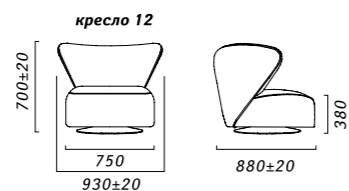

Фокс



1016, 18 гр., 22

1005, 18 гр., 22

1014, 18 гр., 12

1018, 18 гр., 12



1015, 18 гр., 12

1011, 18 гр., 18+12

1017, 18 гр., 12

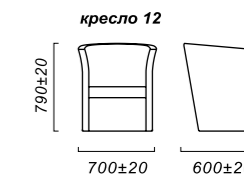

Светач



981, 19 гр.

31591(0), 19 гр.

654, 19 гр.

988, 19 гр.



984, 19 гр.

981, 19 гр.

986, 19 гр.

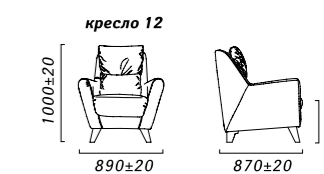

Ронда 1



3(0), 19 гр., 12

484, 19 гр., 12

461, 21 гр., 12

461, 21 гр., 18

462, 21 гр., 12

462, 21 гр., 18

463, 21 гр., 12

463, 21 гр., 18

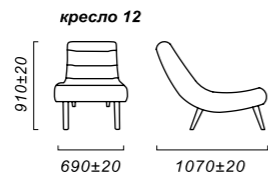

Петра 1



5(0), 19 гр., 12

5, 19 гр., 12

7(0), 19 гр., 12

460, 21 гр., 12

461, 21 гр., 12

462, 21 гр., 12

463, 21 гр., 12

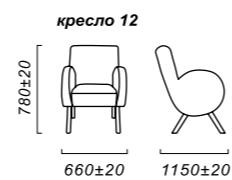

Милорд 1



30174, 20 гр., 12

1017, 18 гр., 12

30173, 20 гр., 12

30164, 20 гр., 12

989, 19 гр., 12

447, 20 гр., 12

30176, 20 гр., 12

1006, 18 гр., 12



658, 19 гр., 12

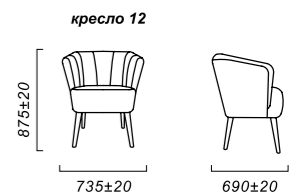

Берли 1



1, 19 гр.,

3(0), 19 гр., 12

5(0), 19 гр., 12

989, 19 гр., 12

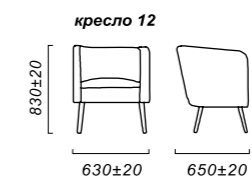

СКОШ 1



362, 21 гр., 12_



365, 21 гр., 12_



952, 19 гр., 12



3(0), 19 гр., 12



5(0), 19 гр., 12



6(0), 19 гр.,



460, 21 гр., 12



461, 21 гр., 12



442, 21 гр., 12



463, 21 гр., 12



800(0), 19 гр., 12

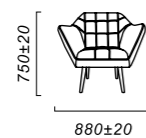

Рунь



31581(0), 19 гр., 12



364, 21 гр., 12



19 гр, 654, 12



21 гр, 565, 12



19гр, 209, 12



21 гр, 558, 12

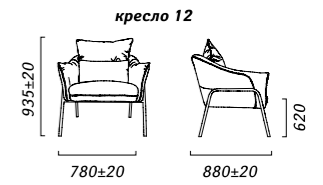

КЭТ



19 гр, 148(0)+148(0)



19 гр, 484+484, 12



19 гр, 652+652, 12



19 гр., 151



19 гр., 216+216

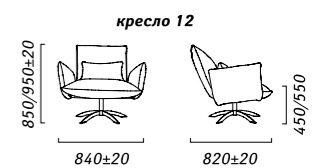

КИСТИ (Латина, Мадлен)



MPR 56-0689



MPR 56-0825



MPR 56-0687



MPR 56-0766



MPR 56-13552

КИСТИ (Цезарь)



MP 102-0109



MP 102-0205



MP 102-0210



MP 102-0632



MP 102-0766



MP 102-13552

Бахрома (Кредо, Латина, Империл)



AC 394B-0855



AC 394B-0724



AC 394B-0687



AC 342-0687



AC 342-0766



AC 342-0689



AC 342-13552

Шнуры

(Royal Collection, Мадлен, Империл, Цезарь, Эстель, Латина, Кредо)



ПЗ-89 бежево-шоколадный



ПЗ-87 золотистый



П-8 персиковый



П-70 бордовый



ПШ-46 белый



ПВ-76 серебристый



П-32 слоновая кость



ПВ-12 молочный



П-58 песочно-коричневый



ПВ-11 золотистый

Крашения декоративных элементов из массивной древесины

Крашение	Слоновая кость с патинной	Слоновая кость с патинной	Слоновая кость с золочением	Слоновая кость с патинной и золочением	Металлик	Венге E-50 B	Орех лесной	Орех светлый E-50A	Орех 2-цветный E50 №10	Орех E50 №10 с золочением	Вишня светлый P-37 A	Вишня темный P-37 B	Вишня 2-цветный P37 №10	Вишня P37 №10 с золочением	Дуб рустикаль с патинной P-43	Античная бронза P-46	Черешня	Платина
					СТ	СТ	СТ	СТ	СТ	СТ	СТ	СТ	СТ	СТ	СТ	СТ	СТ	СТ
Модель																		
Грация	X	X	X	X		X	X	X	X	X	X	X	X	X	X	X	X	X
Рафаэль 1,2	X	X	X	X		X	X	X	X	X	X	X	X	X	X	X	X	X
Николетта 1,2	X	X	X	X		X	X	X	X	X	X	X	X	X	X	X	X	X
Луиза	X	X	X	X		X	X	X	X	X	X	X	X	X	X	X	X	X
Алея	X	X	X	X		X	X	X	X	X	X	X	X	X	X	X	X	X
Амарис	X	X	X	X		X	X	X	X	X	X	X	X	X	X	X	X	X
Астон	X	X	X	X		СТ	СТ	СТ	СТ	СТ	СТ	СТ	СТ	СТ	СТ	СТ	СТ	СТ
Багира	X	X	X	X		СТ	СТ	СТ	СТ	СТ	СТ	СТ	СТ	СТ	СТ	СТ	СТ	СТ
Байрон	X	X	X	X		СТ	СТ	СТ	СТ	СТ	СТ	СТ	СТ	СТ	СТ	СТ	СТ	СТ
Баби	X	X	X	X		СТ	СТ	СТ	СТ	СТ	СТ	СТ	СТ	СТ	СТ	СТ	СТ	СТ
Барни	X	X	X	X		СТ	СТ	СТ	СТ	СТ	СТ	СТ	СТ	СТ	СТ	СТ	СТ	СТ
Бродвей	X	X	X	X		СТ	СТ	СТ	СТ	СТ	СТ	СТ	СТ	СТ	СТ	СТ	СТ	СТ
Бруклин	X	X	X	X		СТ	СТ	СТ	СТ	СТ	СТ	СТ	СТ	СТ	СТ	СТ	СТ	СТ
Боттичелли	X	X	X	X		СТ	СТ	СТ	СТ	СТ	СТ	СТ	СТ	СТ	СТ	СТ	СТ	СТ
Бурже	X	X	X	X		СТ	СТ	СТ	СТ	СТ	СТ	СТ	СТ	СТ	СТ	СТ	СТ	СТ
Виктория	X	X	X	X		СТ	СТ	СТ	СТ	СТ	СТ	СТ	СТ	СТ	СТ	СТ	СТ	СТ
Валер	X	X	X	X		СТ	СТ	СТ	СТ	СТ	СТ	СТ	СТ	СТ	СТ	СТ	СТ	СТ
Валенсия	X	X	X	X		СТ	СТ	СТ	СТ	СТ	СТ	СТ	СТ	СТ	СТ	СТ	СТ	СТ
Вальстер	X	X	X	X		СТ	СТ	СТ	СТ	СТ	СТ	СТ	СТ	СТ	СТ	СТ	СТ	СТ
Верди	X	X	X	X		СТ	СТ	СТ	СТ	СТ	СТ	СТ	СТ	СТ	СТ	СТ	СТ	СТ
Давар 1	X	X	X	X		СТ	СТ	СТ	СТ	СТ	СТ	СТ	СТ	СТ	СТ	СТ	СТ	СТ
Дельга	X	X	X	X		СТ	СТ	СТ	СТ	СТ	СТ	СТ	СТ	СТ	СТ	СТ	СТ	СТ
Дима	X	X	X	X		СТ	СТ	СТ	СТ	СТ	СТ	СТ	СТ	СТ	СТ	СТ	СТ	СТ
Дорнан	X	X	X	X		СТ	СТ	СТ	СТ	СТ	СТ	СТ	СТ	СТ	СТ	СТ	СТ	СТ
Дубай	X	X	X	X		СТ	СТ	СТ	СТ	СТ	СТ	СТ	СТ	СТ	СТ	СТ	СТ	СТ
Дуглас 2	X	X	X	X		СТ	СТ	СТ	СТ	СТ	СТ	СТ	СТ	СТ	СТ	СТ	СТ	СТ
Ева	X	X	X	X		СТ	СТ	СТ	СТ	СТ	СТ	СТ	СТ	СТ	СТ	СТ	СТ	СТ
Изабель-2	X	X	X	X		СТ	СТ	СТ	СТ	СТ	СТ	СТ	СТ	СТ	СТ	СТ	СТ	СТ
Империл 2021	X	X	X	X		СТ	СТ	СТ	СТ	СТ	СТ	СТ	СТ	СТ	СТ	СТ	СТ	СТ
Йорк	X	X	X	X		СТ	СТ	СТ	СТ	СТ	СТ	СТ	СТ	СТ	СТ	СТ	СТ	СТ
Ирис 1	X	X	X	X		СТ	СТ	СТ	СТ	СТ	СТ	СТ	СТ	СТ	СТ	СТ	СТ	СТ
Корлеоне (брессо)	X	X	X	X		СТ	СТ	СТ	СТ	СТ	СТ	СТ	СТ	СТ	СТ	СТ	СТ	СТ
Консул-2(020)	X	X	X	X		СТ	СТ	СТ	СТ	СТ	СТ	СТ	СТ	СТ	СТ	СТ	СТ	СТ
Корса	X	X	X	X		СТ	СТ	СТ	СТ	СТ	СТ	СТ	СТ	СТ	СТ	СТ	СТ	СТ
Кредо	X	X	X	X		СТ	СТ	СТ	СТ	СТ	СТ	СТ	СТ	СТ	СТ	СТ	СТ	СТ
Лаваль	X	X	X	X		СТ	СТ	СТ	СТ	СТ	СТ	СТ	СТ	СТ	СТ	СТ	СТ	СТ
Латина	X	X	X	X		СТ	СТ	СТ	СТ	СТ	СТ	СТ	СТ	СТ	СТ	СТ	СТ	СТ
Лион	X	X	X	X		СТ	СТ	СТ	СТ	СТ	СТ	СТ	СТ	СТ	СТ	СТ	СТ	СТ

Крашения декоративных элементов из массивной древесины

Крашение	Слоновая кость с патинной	Слоновая кость с золочением	Слоновая кость с патинной и золочением	Металлик	Венге E-50 B	Орех лесной	Орех светлый E-50A	Орех 2-цветный E50 №10	Орех E50 №10 с золочением	Видная светлый P-37 A	Видная темный P-37 B	Видная 2-цветный P37 №10	Видная P37 №10 с золочением	Дуб рустикаль с патинной P-43	Античная бронза P-46	Черешня	Платина
Модель																	
Малебра	X				X												
Мадлен	X				X											X	
Милтон	X				X									X (без патины)	X	X	X
Мишель	X				X									X (без патины)	X	X	X
Наоми				СТ													
Нельсон					СТ												
Николь	X		X		X									X			X
Оскар	X				СТ	X											
Осорио					СТ												
Парис					СТ												
Персей					СТ	X											
Роберто					X									X (без патины)		X	X
Сэмюэл					X									СТ (без патины)			
София					X											X	X
Томсон					СТ												
Уно					X					X				X		X	X
Фландрия					X									X (без патины)		X	X
Фарго					СТ												
Хиллари				X													
Хилл				X												X	X
Цезарь (опоры)					X											X	X
Шолен					СТ												

В модели УНО можно комбинировать крашения. Например, Ножки в цвете E-50A+ Нижний пояс в крашении ВЕНГЕ (т.е. E-50A+ВЕНГЕ)

Рекомендации по крашению опор из массива древесины

Наименование изделия	Цвет крашения		
	Лак	Чёрный	Wotan
Лорд	X	СТ	-
Марсел	X	X	СТ
Лира	X	СТ	-
Оскар	X	СТ	-
Скош	X	СТ	-
Милорд	X	СТ	-
Латте	X	-	-
Орио	X	СТ	-
Берли	X	СТ	-
Петра	X	СТ	-
Рондо	СТ	X	-

Декоративные элементы из МДФ, облицованных пленками

Наименование изделия	Цвет декоративной пленки	
	Сосна рандерс	Венге
Азалия		СТ (стандарт)
Болонь		СТ (стандарт)
Матисс		СТ (стандарт)
Матео	X	СТ (стандарт)
Мелисса		СТ (стандарт)
Орегон 1		СТ (стандарт)

Крашения декоративных элементов из массивной древесины унитарное предприятие «Пинскдрев-Евро-Мебель»

Наименование изделия	Рустикаль (B-4)	Слоновая кость (B-2)	Темный орех (E-2)	Венге	Бук натуральный
	Бул		X		X
Бэк-1	X	X		СТ	
Бэк-2	X	X		СТ	
Канон-1	X	X			
Магнат	СТ		СТ		
Палац	X	X		СТ	
Пино-1				СТ	
Тим	X	X		X	СТ
Хэппи		X		X	СТ
Энди		X		X	СТ
Кауа (Кайя)	X	X		СТ	
Кауа-1 (Кайя-1)	X	X		СТ	
Ветразь				X	СТ
Завая				X	СТ
Золак	X	X		СТ	
Светач				СТ	
Скарб				X	СТ

X - возможный вариант крашения, СТ - стандартный вариант крашения, который будет использован в случае, если в заявке не будет указан желаемый цвет декора.

Условные обозначения модулей

12 Кресло	1M Кресло раскладное с механизмом трансформации	1L Секция боковая 1-местная (левая)	1R Секция боковая 1-местная (правая)	30 Секция 3-местная без боковин без механизма трансформации	30M Секция 3-местная без боковин с механизмом трансформации	3M Тахта с механизмом трансформации
20 Секция 2-местная без боковин без механизма трансформации	20M Секция 2-местная без боковин с механизмом трансформации	2L Секция боковая 2-местная (левая)	2R Секция боковая 2-местная (правая)	4L Секция без механизма подъема (левая)	4R Секция без механизма подъема (правая)	0L Кушетка
22, 25 Диван 2-местный	2M, 25M Диван раскладной 2-местный с механизмом трансформации	2ML Секция боковая 2-местная с механизмом трансформации (левая)	2MR Секция боковая 2-местная с механизмом трансформации (правая)	4ML Секция (оттоманка) с подъемным элементом (левая)	4MR Секция (оттоманка) с подъемным элементом (правая)	0R Кушетка
32 Диван 3-местный	3M Диван раскладной 3-местный с механизмом трансформации	3L Секция боковая 3-местная (левая)	3R Секция боковая 3-местная (правая)	6ML Секция (оттоманка) с подъемным элементом (левая)	6MR Секция (оттоманка) с подъемным элементом (правая)	90 Секция угловая
3ML Диван раскладной 3-местный с боковой тумбой слева	3MR Диван раскладной 3-местный с боковой тумбой справа	3ML Секция боковая 3-местная с механизмом трансформации (левая)	3MR Секция боковая 3-местная с механизмом трансформации (правая)	8L/8ML Секция (оттоманка) без/с подъемным элементом (левая)	8R/8MR Секция (оттоманка) без/с подъемным элементом (правая)	18 Банкетка
42 Диван 3-местный	4M Диван раскладной 3-местный с механизмом трансформации	2A, 25A Диван раскладной 2-местный с механизмом трансформации и коробом для белья	3A Диван раскладной 3-местный с механизмом трансформации и коробом для белья	1P Кресло с механическим реклайнером	1E Кресло с электрическим реклайнером	0L Тахта односпальная с механизмом трансформации (стационарная стенка слева)
2PW Диван 2-местный с двумя механическими реклайнерами	2EW Диван 2-местный с двумя электрическими реклайнерами	3PW Диван 3-местный с двумя механическими реклайнерами справа и слева	3EW Диван 3-местный с двумя электрическими реклайнерами справа и слева	1EL/1PL Диван 3-местный с механическим/электрическим реклайнером	1ER/1PR Диван 3-местный с механическим/электрическим реклайнером	0R Тахта односпальная с механизмом трансформации (стационарная стенка справа)
10W Секция 1-местная с электрическим реклайнером	10 Секция 1-местная без боковин без механизма трансформации	5AL Секция (оттоманка) с ящиком для постельных принадлежностей (левая)	5AR Секция (оттоманка) с ящиком для постельных принадлежностей (правая)	5ML Секция (оттоманка) с подъемным элементом (левая)	5MR Секция (оттоманка) с подъемным элементом (правая)	00L Только «Essen» Диван
3ML, 1R Диван раскладной 4-местный с механизмом трансформации слева	3MR, 1L Диван раскладной 4-местный с механизмом трансформации справа	3ML, 90, 1R Диван угловой раскладной с механизмом трансформации	3MR, 90, 1L Диван угловой раскладной с механизмом трансформации	3ML, 90, 2R Диван угловой раскладной с механизмом трансформации	3MR, 90, 2L Диван угловой раскладной с механизмом трансформации	00R Только «Essen» Диван

Модули подушек

Обивка 1
Ткань

Обивка 1
Ткань

Обивка 1
Кожа

Обивка 1
Ткань
Рулик из ППУ

МОДУЛЬ 01
Подушка 440x440

МОДУЛЬ 03
Подушка 380x380

МОДУЛЬ 05
Подушка 350x350

МОДУЛЬ 06
Подушка 400x400

Обивка 1
Ткань

Обивка 1
Кожа

Обивка 1
Кожа

МОДУЛЬ 08
Подушка 600x600
Софья, Мальта-1

МОДУЛЬ 12
Подушка 440x440

МОДУЛЬ 14
Подушка 330x330

Обивка 1
Ткань

Обивка 1
Ткань

Обивка 1
Ткань

Подушки Унитарного предприятия «Пинскдрев-Евро-Мебель»

Подушки: 390x390; 400x400; Подушки: 510x380; 520x400; Подушка 700x440

Условные обозначения

использование в изделии эластичного пенополиуретана

наличие в изделии емкости для хранения постельных принадлежностей

наличие в изделии модульного изготовления

наличие в изделии независимого пружинного блока «Pocket Spring»

возможно изготовление изделия в ткани

наличие в изделии емкости для хранения постельных принадлежностей

наличие в изделии съемного или регулируемого подголовника

наличие в изделии пружины типа «Змейка»

возможно изготовление изделия в коже

наличие в изделии пружинного блока «Bonnell»

наличие в изделии возможности снять боковину(-ы)



www.pinskdev.by



www.pinskdev.ru



www.pinskdev.kz

Производитель оставляет за собой право на внесение изменений в предлагаемых моделях мебели по виду, цвету, конструкции, так как постоянно ведется работа над улучшением качества выпускаемой мебели. Оттенки мебели в каталоге могут отличаться от действительных.